

CNFT[®]

OPERATOR'S MANUAL

FT-7607

航行告警NAVTEX接收机

NAVTEX RECEIVER

福建飞通通讯科技股份有限公司

[FUJIAN FEITONG COMMUNICATION TECHNOLOGY CO., LTD.]

Tel/ +86-595-88481988
Web/ www.cnfeitong.com
Version/ V1.0.0

地址/ 福建省石狮市高新技术开发区电子信息园飞通科技大厦
Addr/ Feitong Technology Building, Electronic Information Park, Hi-Tech
Industrial Development Zone, Shishi City, Fujian Province, China.

福建飞通通讯科技股份有限公司

FUJIAN FEITONG COMMUNICATION TECHNOLOGY CO., LTD.

Safety Instruction

Danger!

- If any object falls into the device or water splashes onto it, immediately turn off the power at the distribution panel.
(Continued use may cause fire or electric shock)
- If the device emits smoke or catches fire, immediately turn off the power at the distribution panel.
(Continued use may cause fire or electric shock)
- If the device operates abnormally, immediately turn off the power at the distribution panel.
(Continued use may cause fire or electric shock; it is recommended to contact the agent/ distributor for consultation)

Warning!

- Be sure to turn off the power at the distribution panel before starting installation.
(Power-on during installation may cause fire or electric shock)
- Use only the specified power cable.
(Using other cables may cause fire or electric shock)
- Do not install the device in locations where it may be exposed to rain or splashing water.
(Water entering the device may cause fire or electric shock)

Caution!

- Ensure the power supply voltage is compatible with the device's rated voltage. Incorrect power connection may cause fire or equipment damage. The rated voltage is indicated on the label on the back of the display unit.
- Handle the grounding copper strap with care; its edges may injure your hands.
- Maintain a minimum compass safe distance of 70MM.
- Grounding the device: Ungrounded equipment may emit or receive electromagnetic interference, or cause electric shock.



Warning!

- Do not perform operations inside the device unless fully familiar with electrical circuits.
- Hazardous voltages exist inside the device that may cause electric shock.

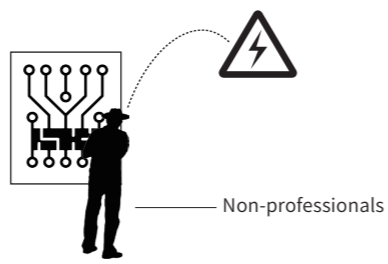

- Before starting installation, turn off the power at the main distribution panel. Post a sign near the switch indicating that the power should not be turned on during installation. Failure to turn off or accidental activation of power during installation may result in fire, electric shock, or serious injury.

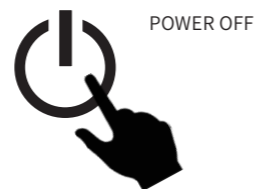

Contents

Safety Precautions	01	■ Display Settings.....	18
Preface	03	■ System Settings.....	19
Main Technical Specification	03	Interface Specification	21-23
Installation	04-07	■ Rear View.....	21
■ System Diagrams.....	04	■ Front View.....	21
■ Main Unit Installation Diagram.....	05	NAVTEX System	25-30
■ Antenna Installation.....	07	■ NAVTEX Introduction.....	24
Overview	08-10	■ Principle of NAVTEX.....	25
■ Main Unit.....	08	■ NAVTEX Message Format.....	26
■ Panel Layout.....	10	■ Global NAVTEX Stations Message List.....	27
Main Functions	12	■ China Domestic NAVTEX (486KHz) Chinese Service Station Broadcast Schedule.....	30
■ Message Reception.....	12	Updates and Maintenance	31-33
■ Message Storage.....	12	■ Diagnostics.....	31
■ Display Function.....	12	■ Device Info.....	31
■ Self-Test Function.....	12	■ Alarm Polling.....	31
■ Alarm Function.....	12	■ Self-test.....	31
■ Printing Function.....	12	■ Reception Monitor.....	32
Basic Function	13-20	■ Reception Test.....	32
■ Power.....	13	■ Screen Test.....	32
■ Brightness.....	13	■ Printer Test.....	32
■ Message List Type.....	13	■ External Cleaning.....	33
■ Message Lock Protection.....	13	■ Fuse replacement.....	33
■ Message Viewing, Printing, and Data Output.....	13	■ Troubleshooting.....	33
■ Alarm Polling.....	14	■ 操作手册中文版.....	34(起)
■ Reception Mode Settings.....	14		

Preface

Thank you for choosing our product, Model: FT-7607, Name:NAVTEX Warning Receiver. The product includes the main unit and accessories provided as standard; please refer to the Packing List for details.Before installing and using this product, please carefully read the User Manual to prevent damage caused by improper operation or lack of professional handling, which may lead to equipment failure or personal safety risks. Our company does not assume any liability for consequences arising from improper use.

※ **Note: If product upgrades or updates result in discrepancies between the User Manual and actual device operation, the device specifications shall prevail.**

Main Technical Specifications

Item Name	Technical Specifications
Receiving Frequency	518KHz, 490KHz, 486KHz, 4209.5KHz
Reception Sensitivity	<4% (2μV e.m.f, 50Ω)
Storage Capacity	>600 records (average length: 512 characters)
Reception Type	F1B
Display Unit	7"LCD, 9"LCD, 12.2"LCD
Power Supply	DC12V~36V
Compass Safe Distance	70cm

Installation

■ System Configuration



..... Optional or usersupplied
 _____ Standard

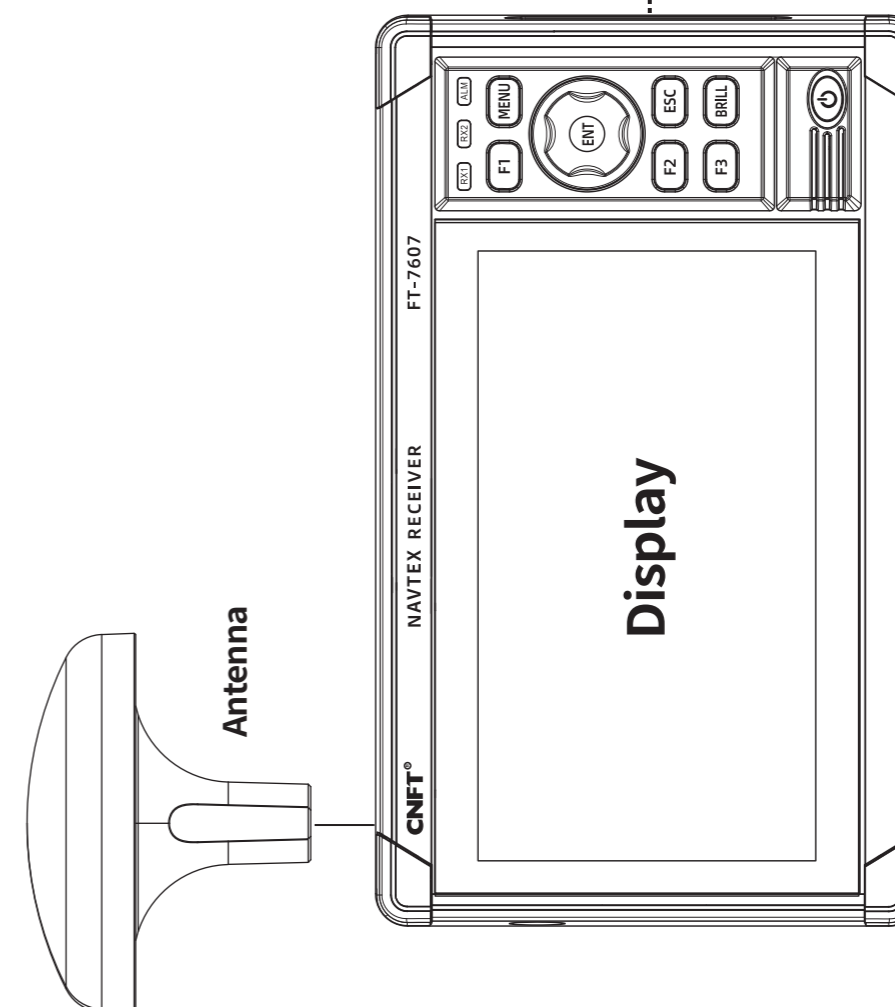

■ Main Unit Installation Diagram

Desktop Mounting

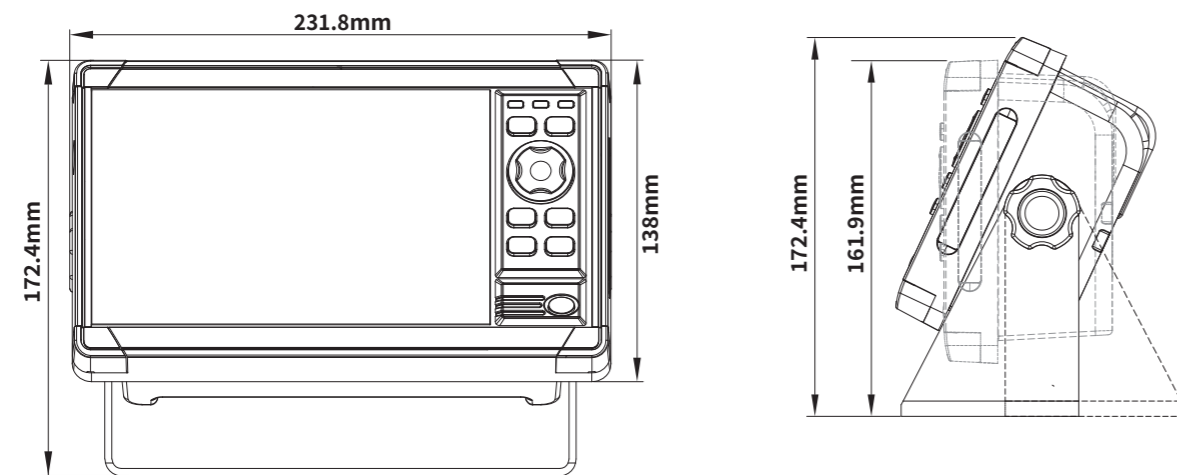

Embedded Mounting

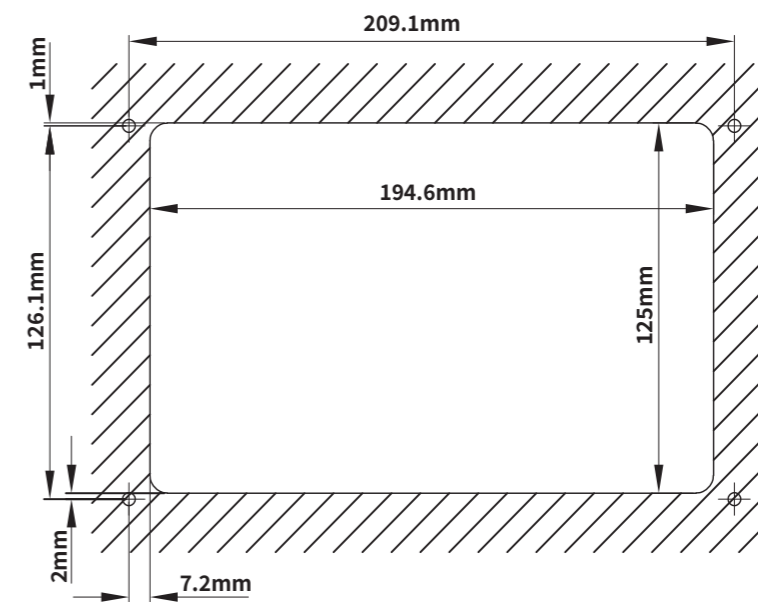
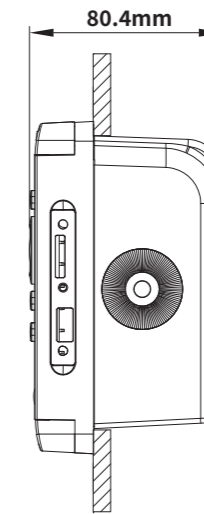
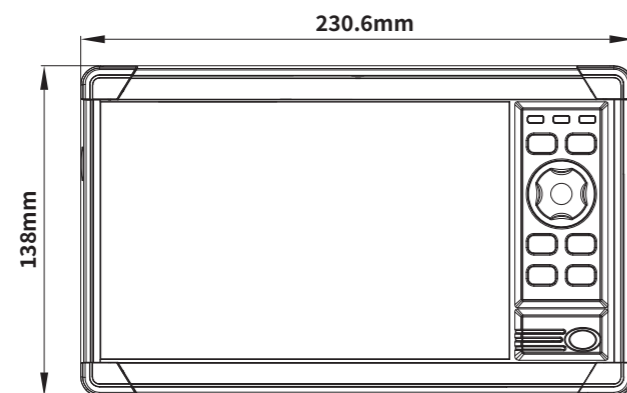

■ Antenna Installation

Proper antenna installation is crucial to minimizing interference and achieving optimal reception distance. Please observe the following guidelines during installation:

1. The antenna should be positioned vertically and kept as far as possible from conductive objects on a horizontal plane. The minimum distance should exceed 0.5 meters. It should not be placed near large vertical objects and should ideally maintain a 360° unobstructed view.
2. The antenna should be kept away from high-power transmitters, such as radar, radio stations, or other radio antennas. A minimum separation of 3 meters is recommended.
3. The antenna cable should be kept away from power cables. If crossing is unavoidable, maintain a 90-degree perpendicular arrangement.
4. The RF antenna cable provided is RG-58. One end is connected to the antenna amplifier, while the other end connects to the receiver unit.

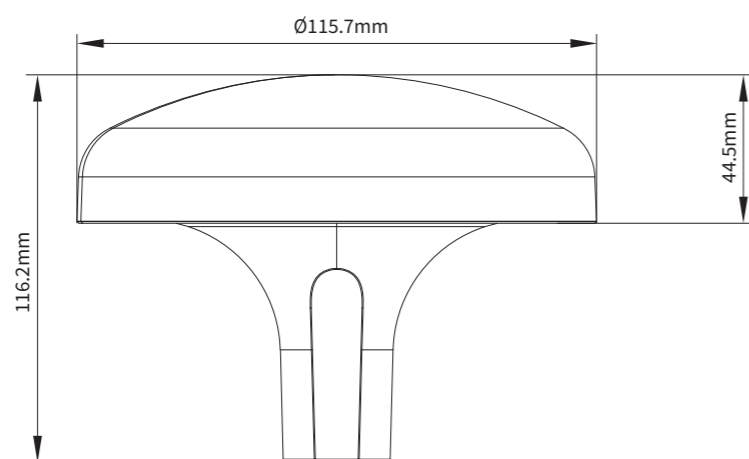
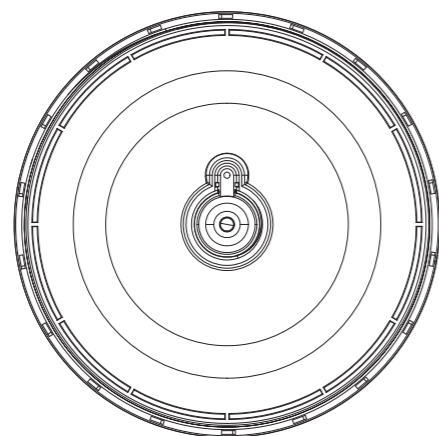

OVERVIEW

■ Main Unit

Panel Description

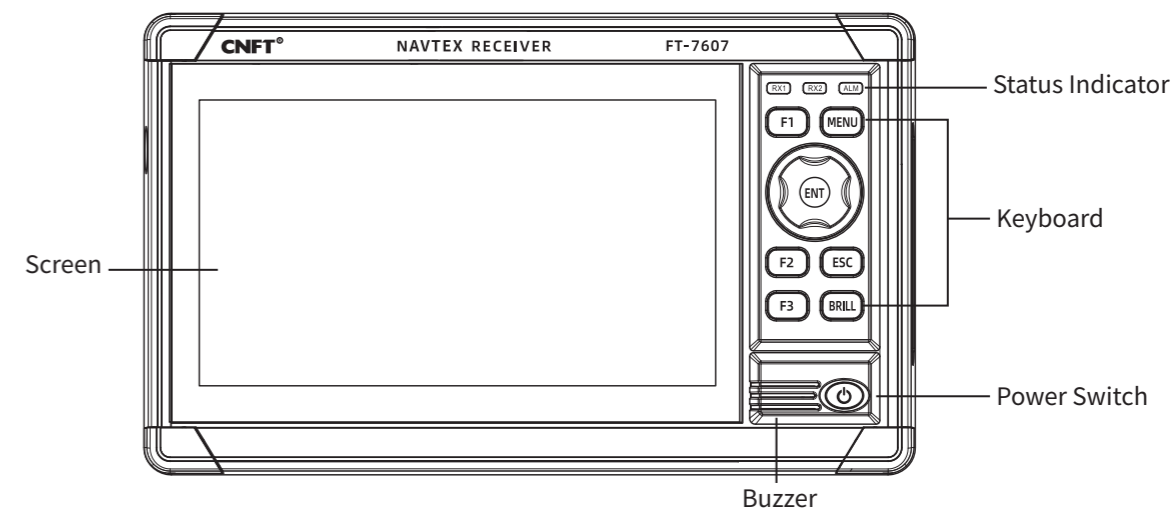

Status Indicator:

	International Channel Reception Indicator: Steady light indicates receiving information; flashing light signifies unread messages in the channel list.
	Local Channel Reception Indicator: Steady light indicates receiving information; flashing light signifies unread messages in the channel list.
	Alarm Indicator: Flashing light indicates an alarm state.

Keyboard:

	Used to move the cursor or select operations
	Corresponds to functions displayed on the screen
	Used to confirm menu functions
	Used to enter the main menu
	Used to cancel operations or exit the main menu
	Enter brightness settings
	Used to turn the machine power on/off

Front View

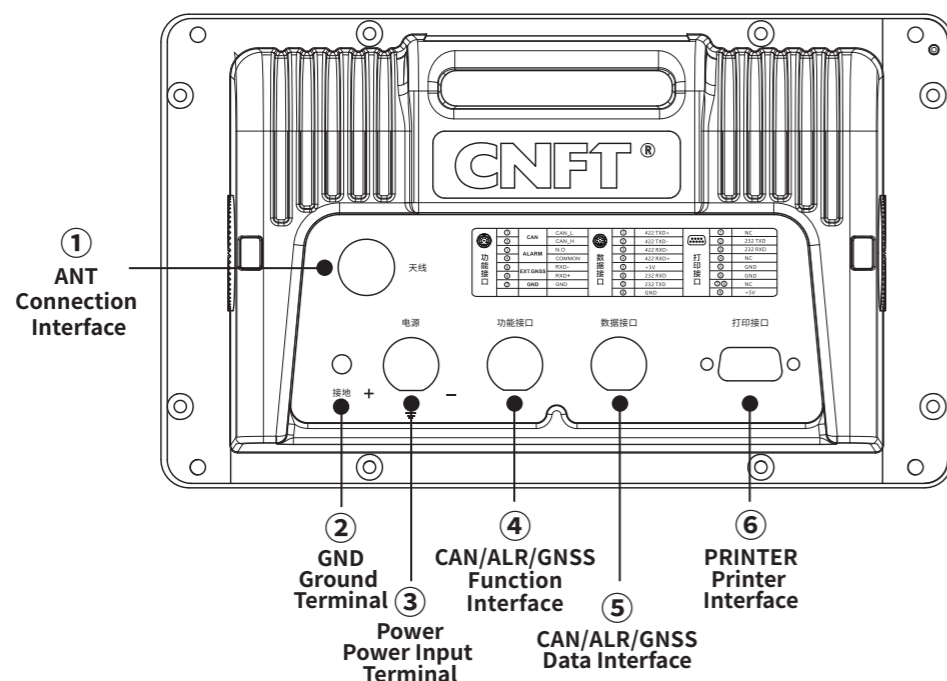

Main Function

Message Reception

- Dual-channel simultaneous message reception and processing.
- Supports both Chinese and English message reception.
- Automatically receives and processes messages after synchronization with a fixed signal.
- Messages with an error rate exceeding 33% will be rejected.
- Reception mode selection includes automatic, manual, and internal navigation options.
- Messages can be received based on preset station information types, except for ABDL-class messages.

Message Storage

- Messages with an error rate below 33% will be automatically saved.
- If the same message is received twice, the version with the lower error rate is saved.
- Each receiver can store up to 256 messages, with an average length of 2000 characters.
- Supports storage of individual messages up to 8000 characters.
- When the number of stored messages exceeds 256, the earliest message is automatically deleted (except protected messages).
- Message storage duration is 60-70 hours, and messages are automatically deleted after 72 hours (including power-off time).
- Locked messages and messages with the number "00" will be permanently saved.

Display Function

- Displays message text; erroneous characters appear as "*" symbols.
- Supports display of 16 lines of text, each containing up to 32 characters.
- When connected to an external GPS input, navigation data such as position, speed, and direction can be displayed.
- Message titles can be displayed based on various filters: All, Alarm, User Selection, Complete, or Custom Lists.
- Displays date, time, and operational prompts.

Self-Test Function

- System self-test capabilities.
- Reception testing features.

Alarm Function



- Supports audible and visual alarms with an output volume of up to 75dBA.
- Alarm tones differentiate between emergency, alert, weather, and general messages.
- Allows selection of message types for alarm triggering.
- Includes alarm record inquiry and alarm output switch functionality.

Printing Function









- Allows automatic or manual selection of messages for printing.
- Supports automatic printing of selected receiving station messages and message types.

Basic Function



Power

Connect the machine to a power source. Press the power button  to turn it on. Press and hold the button  for 3 seconds to turn it off.

Brightness

Press the  key to enter adjustment mode.
Press   keys to adjust the screen brightness.
Press  key, then press   keys to adjust the keyboard brightness.
Press  key again, then press   keys to switch display modes.



Channel List

On the message list interface: Press  to switch shortcut key functions. Press  to toggle between lists. Press  to switch channels. Supports touch screen control. The top left corner of the screen displays the corresponding channels 518K or 490K (486K)/4209.5K. The list displays the message titles received by that channel.









Message List Type

On the message list interface: Press  to cycle through different list types: All, Alarm, User Selection, Full, and Custom Lists. The custom message list can be configured in the **[DISPLAY]** Settings menu, allowing selection of message categories such as Emergency, MET (meteorological), Unread, or Locked.





Message Lock Protection

On the list interface: Press  to lock or unlock the selected message.  icon indicates that the message is locked. Locked messages will not be automatically deleted after 72 hours.

Message Viewing, Printing, and Data Output







In the message list interface, press the  button to display the message content at the current cursor position. The screen enters the message display interface. Use the  and  buttons to browse the message content, and the  and  buttons to select the previous or next message. Press the  button, the screen shows a prompt "Output current message data via INS port? Yes/ No", press  to select **YES**, and then press  to confirm the data output. The machine then outputs the current message data through the INS interface.



Press the  button, the screen shows a prompt "Print the current message? Yes/No", press  to select **YES**, and then press  to confirm the printing. The screen shows  the icon. At this point, the machine outputs the printed message to the printer via the printing interface.











Alarm Polling

Press the  key to enter the main menu display; press the  key to select the **[DIAGNOSTICS]** submenu; Press the  key to select **[ALARM POLLING]**; press the  key to enter the alarm query screen; Press the   keys to select the alarm message line; press the  key to confirm the alarm message.

※**Note: If all the alarm message in the alarm query screen is confirmed, the alarm output and indicator light will automatically cancel.**

Reception Mode Settings

Press the  key to enter the main menu display; Press the  key to select the **[NAVTEX]** submenu; Press the  key to enter the submenu; Press the   keys to select an item; Press the   keys to modify settings, or press the  key to enter the corresponding item for editing settings.

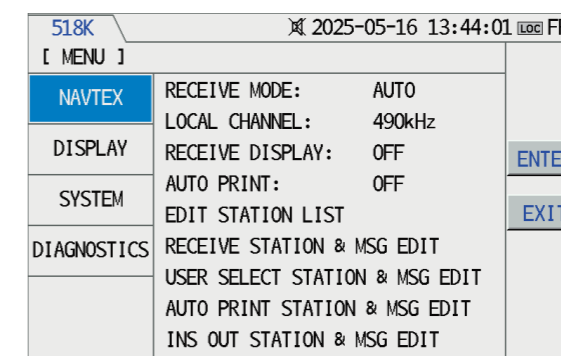

Reception Mode

In the **[RECEIVE MODE]** option can be set to: Auto/ Manual/ INS (Internal Navigation System, used to select the method for the device to receive NAVTEX message.

[AUTO]: When valid external navigation data input is available, the device automatically determines reception based on the range of transmitting stations. If there is no navigation data input, the device will receive from all transmitting stations.

[MANUAL]: The device receives according to the stations and message types selected by the user.

[INS]: Internal Navigation System Mode, the Device receives according to the stations and message types input by the INS.

◇ Local Channel

This option can be set to: 490KHz (486KHz) / 4209.5KHz, used to select the operating frequency of the device's local channel. 486KHz is the Chinese NAVTEX Chinese message service channel, allowing the device to receive Chinese message.

◇ Reception Display

This option can be set to: On/Off, to determine whether to display a prompt for new message. When set to On, upon receiving a new message, the screen displays a "DISPAY NEW MSGS? Yes/No" prompt, allowing the choice to display the message text.



◇ Auto Print

This option can be set to: Off/All/User Selection, used to choose whether to automatically print certain received messages.

All: As soon as a new message is received, the device automatically prints it out.

User Select: The device only prints out messages from the stations and message types selected by the user; otherwise, it does not print.

◇ Edit Station List

This option is used to set the station message for 16 global navigation areas. Each navigation area can set message for 32 stations, including: station name, station coordinates, station transmission channel identifier (B1), and coverage area.

Editing Station Message:

Press the [MENU] key to enter the main menu display.

Press the [▶] key to select the [NAVTEX] submenu.

Press the [▼] key to select [EDIT STATION LIST].

Press the [F2] key to enter the [EDIT STATION LIST] screen; as shown in the figure.

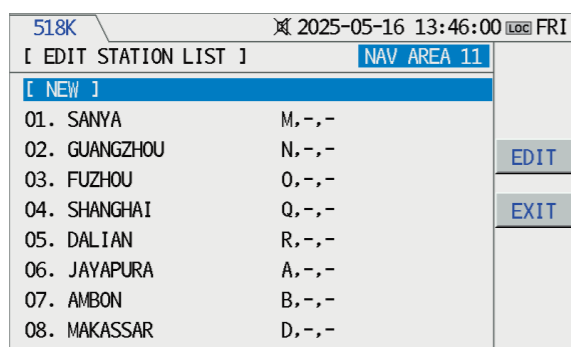

Press the [◀] [▶] keys to select the navigation area (01-16), Press the [▲] [▼] keys to select the station or [NEW] to add a new one, press the [F2] key to enter the station message editing screen, Press the [▲] [▼] keys to select the station or [NEW] to add a new one, press the [F2] key to enter the station message editing screen. Press the [▲] [▼] keys to select the station message item. Select "EDIT" to modify the station message parameters. After editing, press the [F2] key, press the [▼] key to select "SAVE SETTING?" Press the [ESC] key, the screen will display the prompt "SAVE STATION MSG? Yes/No," press the [◀] key to select YES, Press the [F2] key to confirm and save the settings.



Enter the [EDIT STATION LIST] screen, press the [▲] [▼] keys to select the station, press the [F3] key, and the screen will display the "DELETE STATION MSG? Yes/ No" prompt. Press the [◀] key to select YES, and press the [F2] key to confirm the deletion of the station.

※**Note:** Do not delete station message arbitrarily, as it may affect the reception judgment of the automatic reception mode and cause message to not be received.



◇ Reception Station & MSG Type

When the device's reception mode is set to Manual, it receives based on the settings for reception stations and message types. This function allows for the selective reception of station message.

Press the [MENU] key to enter the main menu display. Press the [▶] key to select the [NAVTEX] submenu.

Press the [▼] key to select [RECEPTION STATION & MSG TYPE]. Press the [F2] key to enter the [RECEPTION STATION & MSG TYPE] screen.

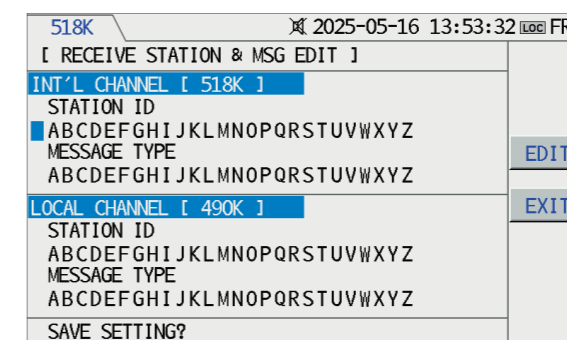

Press the [▲] [▼] keys to select an item, Press the [◀] [▶] keys to select the position of the [Station or Message Type] you want to modify. After selecting the setting, press the [▲] [▼] keys to modify. Press the [▼] key to select "SAVE SETTING?". Press the (F2) key, the screen will display the prompt "SAVE RX STATION? Yes/No," press the [◀] key to select, and press the (F2) key to confirm and save the settings.



◇ User Select Station and Message Type

This option allows configuration of user-selected stations and message types. When the device's [MESSAGE LIST], [AUTO PRINT], and [ALARM MESSAGE] are set to User Selection, the device will process messages according to these settings. Press the (MENU) key to enter the main menu display; Press the [▶] key to select the [NAVTEX] submenu; Press the [▼] key to select [USER SELECT STATION & MSG TYPE];

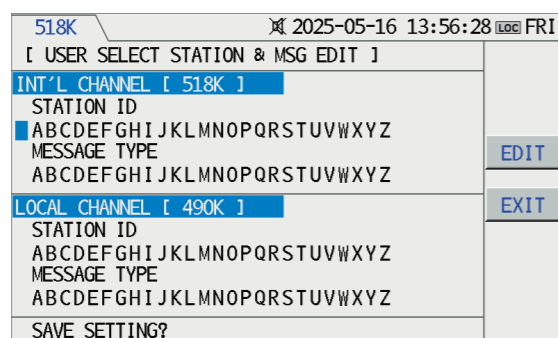

Press the [▲] [▼] keys to select an item,
Press the [◀] [▶] key to choose the position to be modified [Station or Message Type], and press the [▲] [▼] keys to make changes. After selecting the settings, press the [▼] key to choose "SAVE SETTING",
Press the (F2) key, the screen will display the prompt "Save user selection settings? Yes/No,"
Press the [▶] key to select YES, and press (F2) to confirm and save the settings.

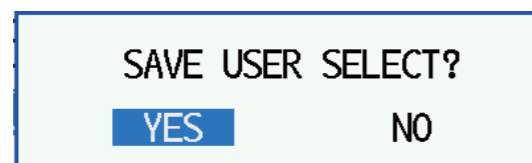

■ Display Settings

Press the (MENU) key to enter the main menu display, press the [▲] [▼] keys to select [DISPLAY].
Press the [▶] key to select the [DISPLAY] submenu.
Press the [▼] key to enter the submenu, the screen will display as shown. Press the [▲] [▼] keys to select an item.
Press the [◀] [▶] keys to modify settings.

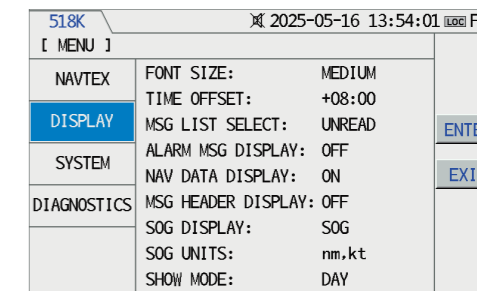

◇ Font Size

This option can be set to: Small/Medium/Large, used to select the display font for English characters. Small font (6×9), Medium font (7×14), Large font (14×22). The display font for Chinese messages is not controlled and defaults to (16×16).

◇ Time Offset

Used to set the time offset (Beijing time difference is UTC+8:00). The current time displayed on the device screen is adjusted accordingly.

◇ Custom Message List

This option can be set to: Urgent Messages, Met Messages, Unread Messages, Locked Messages, used for selecting from the custom message list.

◇ Alarm MSG Display

This option can be set to: On/Off. When set to On, as soon as an alarm is triggered, the device screen will display an alarm prompt box as shown, then press any key to confirm and clear the alarm.



◇ Navigation Data Display

This option can be set to: On/Off, and is used to control the display of the "navigation data display box" on the message list screen.

◇ MSG Header Display

This option can be set to: On/Off. When set to On, the message title will display the position coordinates and distance from the transmitting station when viewing the message content.

◇ Speed Type

This option can be set to: SOG (Speed Over Ground)/STW (Speed Through Water), used to select the type of speed displayed in the navigation data display box.

◇ Speed Unit

This option can be set to: "nm,Kt" (Nautical Miles/Knots), "Km,Km/h" (kilometers/kilometers Hour), "mi,mil/h" (Miles,Miles/Hour), used to select the unit of speed.

◇ **Screen Mode**

This option can be set to: Day/Night, to change the screen display mode.

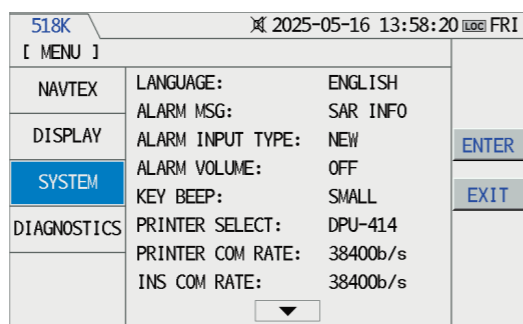

■ **System Settings**

Press the **[MENU]** key to enter the main menu display, press the **[▲]** **[▼]** keys to select **[SYSTEM]**. Press the **[▶]** key to select the **[SYSTEM]** submenu; Press the **[▼]** key to enter the submenu, the screen will display as shown; Press the **[▲]** **[▼]** keys to select an item. Press the **[◀]** **[▶]** keys to modify settings.

◇ **Language**

This option can be set to: Chinese/English, used to change the screen display text except for the message content.

◇ **Alarm MSG**

This option can be set to: SAR MSG (Search and Rescue Message) / WARN MSG (Warning Message/User Selection/All, used to select the type of alarm message.

The device will emit the following repeated sounds every 2 seconds

- 1. Search and Rescue Message (----)
- 2. Search and Rescue Message (---)
- 3. Search and Rescue Message (——)
- 4. Search and Rescue Message (———)

◇ **Alarm Volume**

This option can be set to: Off/Low/Medium/High, used to set the volume of the alarm tone.

◇ **Key Beep**

This option can be set to: Off/Low/Medium/High, used to control the tone when operating the keys. The effective key tone is "beep", and the invalid key tone is "buzz".

◇ **Printer Select**

This option can be set to: FT-58M/DPU-414, used to select the model of the printer that can be connected.

◇ **INS COM Rate**

This option can be set to: 4800b/s, 9600b/s, 19200b/s, and 38400b/s, used to select the baud rate of the INS port input/output data.

◇ **Printer Port Rate Setting**

This option can be set to: 4800b/s, 9600b/s, 19200b/s, and 38400b/s, used to set the baud rate of the NMEA input port data.

◇ **NMEA In COM Rate**

This option can be set to: 4800b/s, 9600b/s, 19200b/s, and 38400b/s, used to set the baud rate of the NMEA input port data.

◇ **Date & Time Settings**

Press the **[MENU]** key to enter the main menu display. Press the **[▶]** key to select the **[SYSTEM]** submenu; Press the **[▼]** key to select **[DATE&TIME SETTING]**; Press the **[F2]** key to enter the time and date settings state, the screen will display as shown.

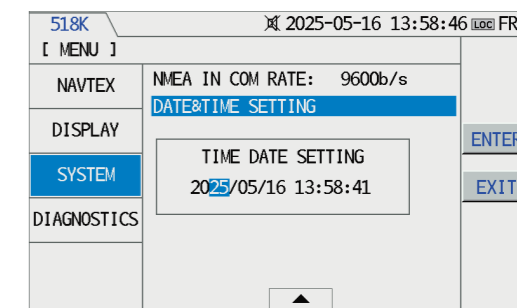

Press the **[◀]** **[▶]** keys to select and modify the year/month/day/hour/minute/week, Press the **[▲]** **[▼]** keys to modify the time, Press the **[F2]** key, the screen will display the prompt "SAVE INT CLOCK? Yes/No," press the **[◀]** key to select **YES** and press the **[F2]** key to confirm the internal clock update. At this point, the time and date settings are successful.

※ **Note: To ensure synchronization of the time source, please set the time and date according to international time.**



Interface Specification

■ Rear View

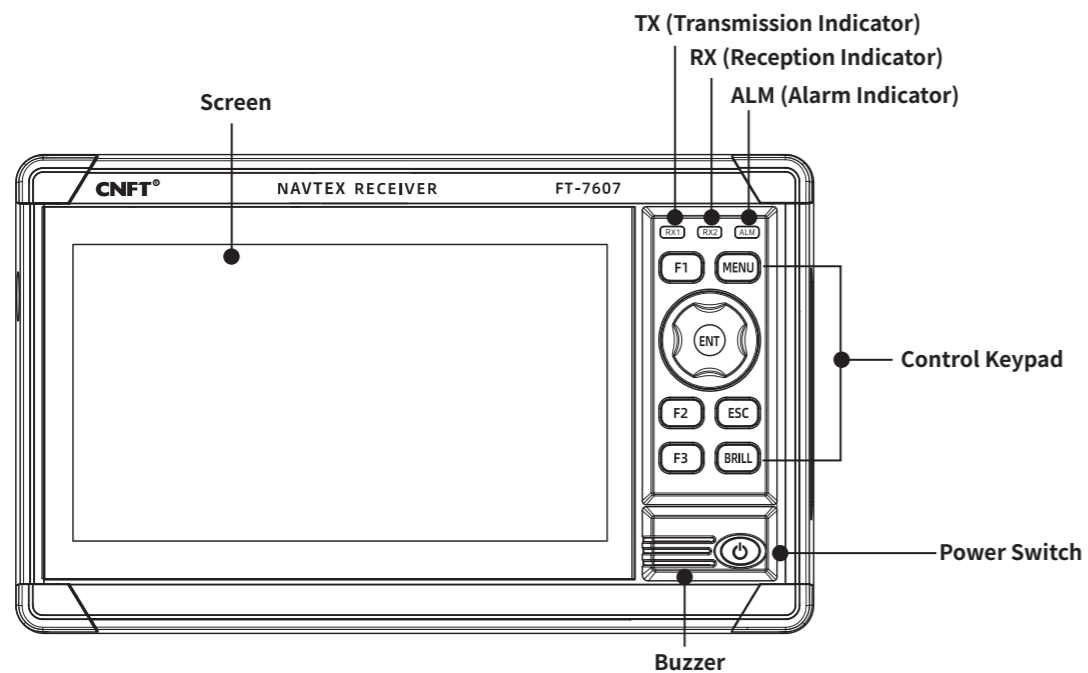

■ Front View

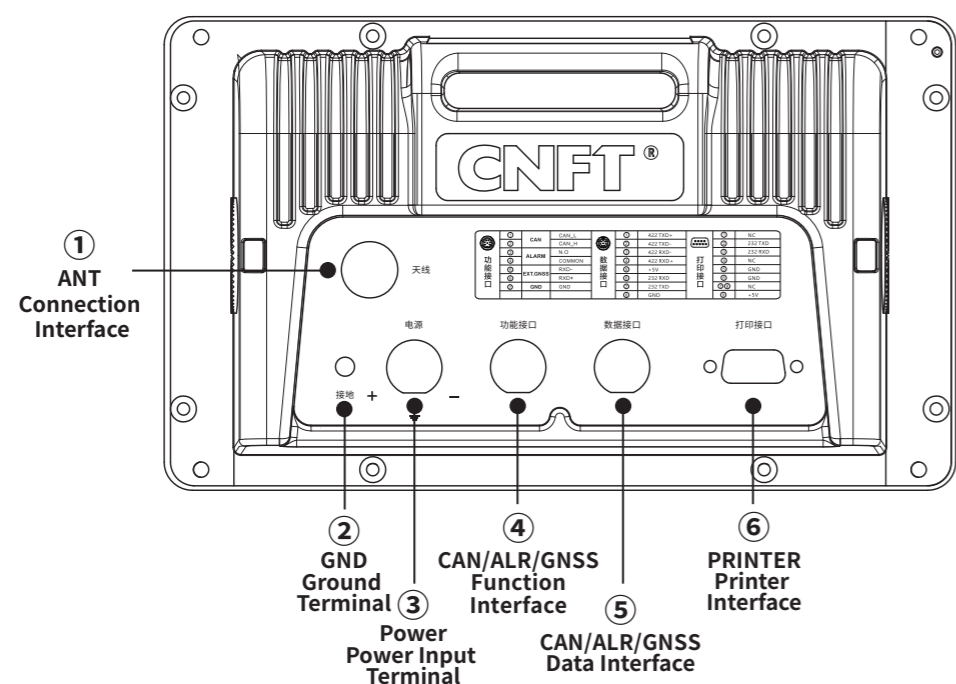

Rear Interface Specifications

- ① ANT (Dedicated Interface for Outdoor Receiver Unit)
- ② GND (System Ground Terminal)

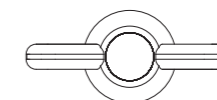

- ③ POWER (Power Input Terminal (12V DC, Operating Range: 10.8V-15.6V))

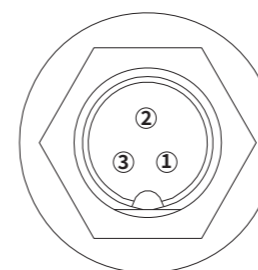

- 1. Power Input Negative (-)
- 2. Ground (GND)
- 3. Power Input Positive (+)

- ④ CAN/ALR/GNSS(Multi-Function Interface)

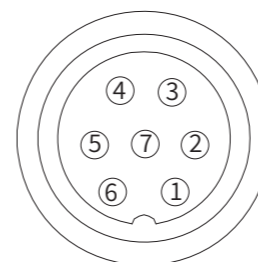

No.	Definition	Function
1	CAN_L	CAN Communication Interface_L
2	CAN_H	CAN Communication Interface_H
3	N.O	Alarm Interface Normally Open Contact
4	COMMON	Alarm Interface Common Contact
5	RXD-	GNSS Positioning Input (-)
6	RXD+	GNSS Positioning Input (+)
7	GND	Ground

⑤ INS/BAM(Data Interface)

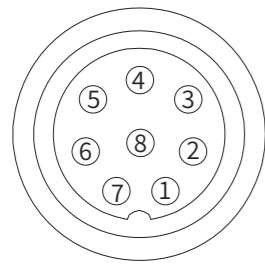

NO.	Definition	Function
1	TX_422+	RS422 Serial Output (+)
2	TX_422-	RS422 Serial Output (-)
3	RX_422-	RS422 Serial Input (-)
4	RX_422+	RS422 Serial Input (+)
5	+5V	DC 5V、200mA
6	RX_232	RS232 Serial Input
7	TX_232	RS232 Serial Output
8	GND	Ground

⑥ PRINTER(Printer Interface)

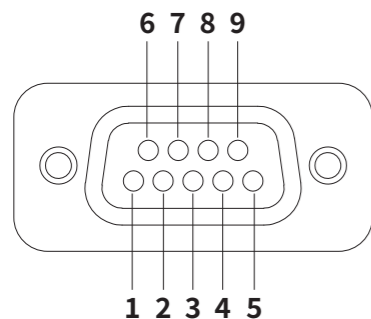

No.	Definition	Function
1	NC	Empty
2	PRT TXD	Data Output
3	PRT RXD	Data Input
4	NC	Empty
5	GND	Ground
6	GND	Ground
7	RES	Reset
8	SCK	Clock
9	+5V	Power Output

NAVTEX System

NAVTEX Introduction

NAVTEX (Navigational Telex) is a maritime communication system that uses radio telex for transmitting and receiving direct printing telegraph messages. Through this service, ships can automatically receive maritime safety information from coastal radio broadcasts, such as search and rescue messages, navigational warnings, meteorological warnings, weather forecasts, and other urgent information. This service provides a convenient, automatic means for vessels at sea to obtain maritime safety information.

NAVTEX is a component of the World-Wide Navigational Warning Service (WWNWS). The global NAVTEX service, along with the INMARSAT system's safety communication network, forms the Global Maritime Distress and Safety System (GMDSS). NAVTEX messages are broadcast globally on the standard frequency of 518 kHz and on national frequencies designated by individual countries. NAVTEX receivers are mandatory equipment on vessels subject to international conventions.

1. The international NAVTEX system uses the dedicated frequency of 518 kHz, employing Narrow Band Direct Printing (NBDP) with Forward Error Correction (FEC) mode, and the transmission type is F1B, broadcasting maritime safety information to ships navigating along coastlines. Ships equipped with NAVTEX receivers automatically receive and can independently choose to print out broadcasted maritime safety information. The NAVTEX system consists of onshore MSI providers, NAVTEX transmitting stations, and onboard NAVTEX receivers.

2. Domestic NAVTEX services refer to the broadcasting and automatic reception of maritime safety information in the national language on the frequencies designated by each country (one medium frequency and 4209.5 kHz).

The FT-7607 receiver can receive NAVTEX broadcasts in both English and Chinese on the frequencies of 518 kHz (international frequencies) and 490 kHz, 486 kHz/ 4209.5 kHz (domestic frequencies).

NAVTEX Concept Diagram

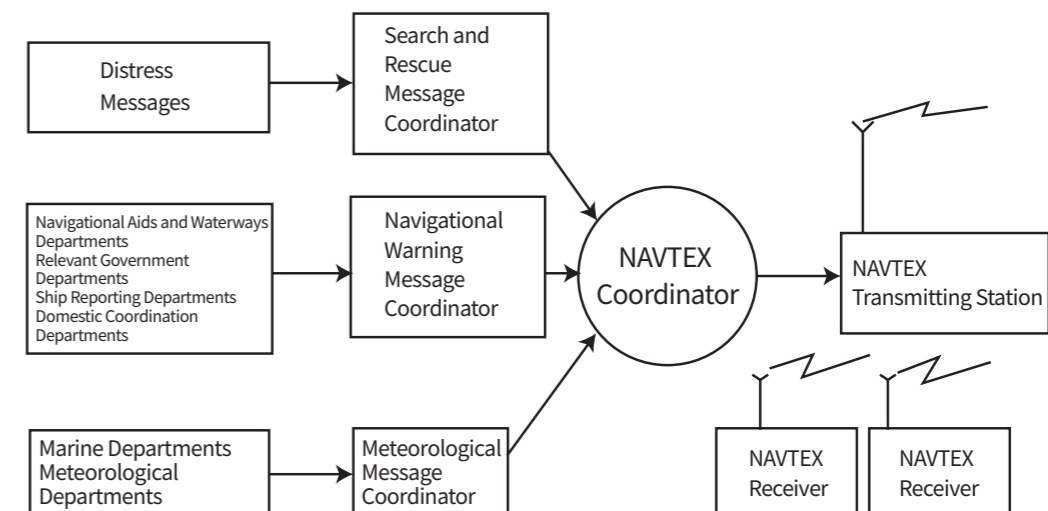

■ Principle of NAVTEX

The International Maritime Organization (IMO) has divided the world into 16 navigational areas. Each navigational area is equipped with several transmitting stations forming a network. Each shore station in these areas uses radio telex to broadcast navigational warnings, weather forecasts, and emergency messages. To ensure global system consistency, a unified broadcast frequency of 518 kHz is used for international NAVTEX, transmitting safety messages in English. The broadcast times are globally coordinated to maintain NAVTEX broadcast harmony, as outlined in section [1.4]NAVTEX Transmitting Shore Stations and Broadcast Times].

Each shore station's transmission power is strictly regulated to prevent interference between stations. Typically, the coverage range of a shore station is about 250 to 400 nautical miles.

Standard NAVTEX receivers can select messages for reception and printing based on the received message identifier (B1B2B3B4). However, certain safety messages, such as navigational warnings, meteorological warnings, and search and rescue messages, cannot be refused as they are crucial for safe navigation.

According to the [Figure 1-1 NAVTEX Concept Diagram], the NAVTEX coordinating authority manages and coordinates the transmission of messages by shore stations based on message content and the coverage area of each shore station. This ensures that NAVTEX receivers only receive messages from one or a few shore stations.

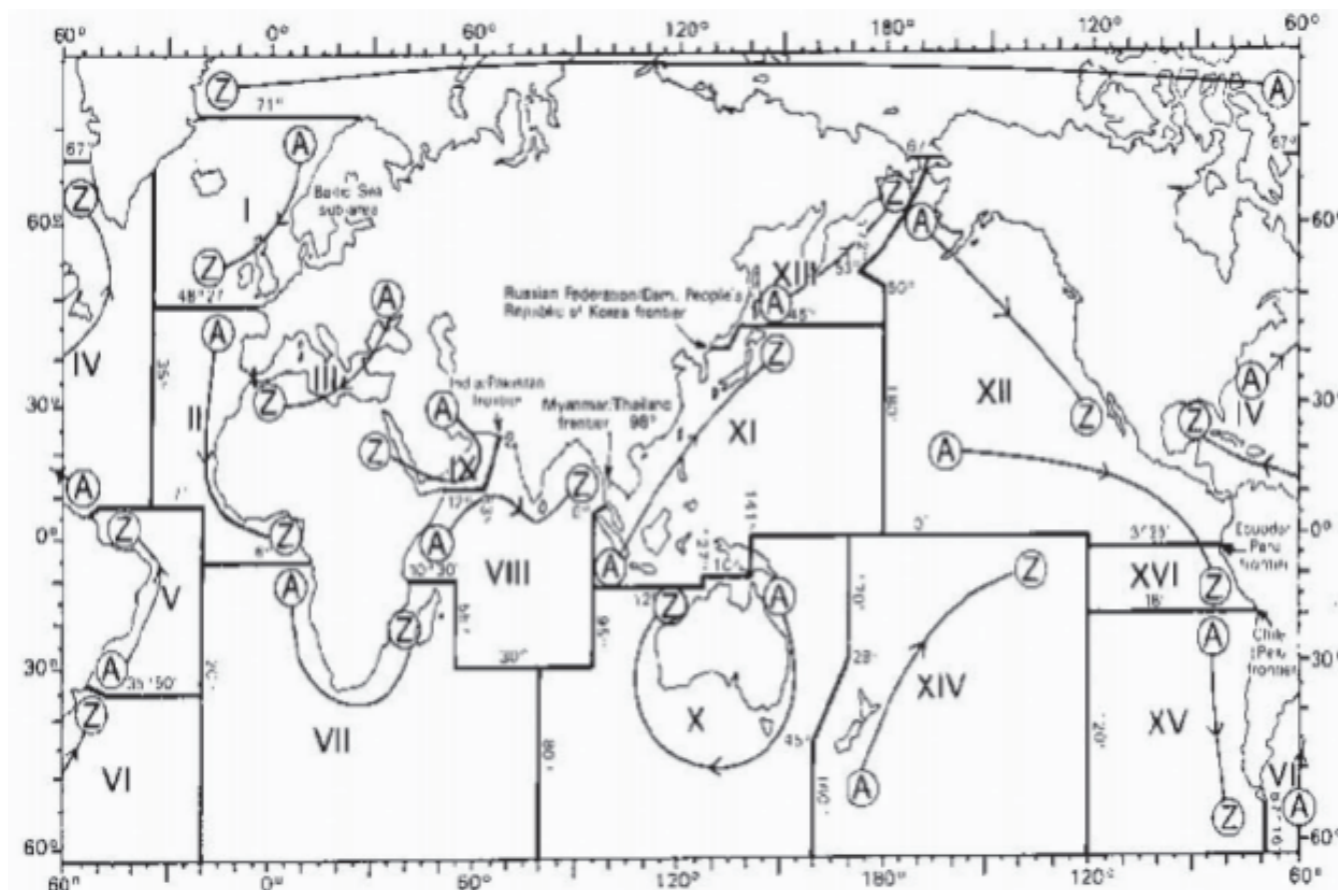

■ NAVTEX Message Format

phasing signal	ZCZC	B1	B2	B3	B4	Message	NNNN
----------------	------	----	----	----	----	---------	------

phasing signal: A synchronization signal used to synchronize with the transmitting station, lasting longer than 10 seconds.

ZCZC : Start signal indicating the beginning of the message reception.

B1(A-Z): Transmitting station identifier, used to identify the transmitting station, e.g., Fuzhou station's identifier is "0".

B2(A-Z): Message type identifier. Refer to [Table 1-1] for details.

B3, B4(00-99): Message serial number, ranging from 01-99. The number 00 is used exclusively for important messages, such as SAR (Search and Rescue). Any message numbered 00 will be unconditionally displayed or printed and permanently stored in the device.

Message : The content of the message.

NNNN : End signal indicating the end of the message reception.

Message Type Identifier Letters

Message Type Identifier Letters(B2)	Explanation
A*	Navigational Warning
B*	Meteorological Warning
C	Ice Report
D*	Search and Rescue Information Piracy and Armed Robbery
E	Meteorological Forecast
F	Pilot Message
G	AIS Message
H	LORAN-C Message
I	Reserved presently not used
J	SATNAV Message
K	Other Electronic Navigational Aid system Message
L*	Navigational Warning(additional)
M to Y	Reserved presently not used
Z	QRU(no message on hand)

※Note: The receiver will not reject message types marked with a "*".

Global NAVTEX Stations Message List

NAV Area	Country	Station	Latitude	Longitude	Frequency (KHz)	Range (NM)	ID	Broadcast Times (UTC)	
I	Belgium	Oostende	51° 11' N	02° 48' E	518	55	T	0310, 0710, 1110, 1510, 1910, 2310	
	Estonia	Tallinn	59° 30' N	24° 30' E	518	250	U	0320, 0720, 1120, 1520, 1920, 2320	
	Iceland	Reykjavik Radio		64° 05' N	21° 51' W	518	550	R	0250, 0650, 1050, 1450, 1850, 2250
						490	550	R	0318, 0718, 1118, 1518, 1918, 2318
	Ireland	Valentia		51° 27' N	09° 49' W	518	400	W	0340, 0740, 1140, 1540, 1940, 2340
		Malin Head		55° 22' N	07° 21' W	518	400	Q	0240, 0640, 1040, 1440, 1840, 2240
	France	Niton		50° 35' N	01° 18' W	518	270	K	0140, 0540, 0940, 1340, 1740, 2140
	Netherlands	Den Helder		52° 06' N	04° 15' E	518	110	P	0230, 0630, 1030, 1430, 1830, 2230
	Norway	Bodø Radio		67° 16' N	14° 23' E	518	450	B	0010, 0410, 0810, 1210, 1610, 2010
		Rogaland		58° 48' N	05° 34' E	518	450	L	0150, 0550, 0950, 1350, 1750, 2150
		Vardø Radio		70° 22' N	31° 06' E	518	450	V	0330, 0730, 1130, 1530, 1930, 2330
		Svalbard Islands		78° 04' N	13° 38' E	518	450	A	0000, 0400, 0800, 1200, 1600, 2000
		Orlandet		63° 40' N	09° 33' E	518	450	N	0210, 0610, 1010, 1410, 1810, 2210
	Sweden	Bjuröklubb		64° 28' N	21° 36' E	518	300	H	0110, 0510, 0910, 1310, 1710, 2110
		Gislövshammar		55° 29' N	14° 19' E	518	300	J	0130, 0530, 0930, 1330, 1730, 2130
		Varberg		57° 06' N	12° 23' E	518	300	D	0030, 0430, 0830, 1230, 1630, 2030
	United Kingdom	Cullercoats		55° 02' N	01° 26' W	518	270	G	0100, 0500, 0900, 1300, 1700, 2100
						490	270	U	0320, 0720, 1120, 1520, 1920, 2320
		Portpatrick		54° 51' N	05° 07' W	518	270	O	0220, 0620, 1020, 1420, 1820, 2220
						490	270	C	0020, 0420, 0820, 1220, 1620, 2020
		Niton		50° 35' N	01° 18' W	518	270	E	0040, 0440, 0840, 1240, 1640, 2040
						490	270	I	0120, 0520, 0920, 1320, 1720, 2120
		Oostende		51° 11' N	02° 48' E	518	150	M	0200, 0600, 1000, 1400, 1800, 2200
	II	France	Cross Corsen	48° 28' N	05° 03' W	518	300	A	0000, 0400, 0800, 1200, 1600, 2000
490						300	E	0040, 0440, 0840, 1240, 1640, 2040	
Niton			50° 35' N	01° 18' W	490	270	T	0310, 0710, 1110, 1510, 1910, 2310	
					518	640	F	0050, 0450, 0850, 1250, 1650, 2050	
Portugal		Horta		38° 32' N	28° 38' W	518	640	F	0050, 0450, 0850, 1250, 1650, 2050
						490	530	G	0100, 0500, 0900, 1300, 1700, 2100
Spain		La Coruña		43° 21' N	08° 27' W	518	400	D	0030, 0430, 0830, 1230, 1630, 2030
		Tarifa		36° 01' N	05° 34' W	518	400	G	0100, 0500, 0900, 1300, 1700, 2100
		Las Palmas		28° 10' N	15° 25' W	518	400	I	0120, 0520, 0920, 1320, 1720, 2120
III	Bulgaria	Varna	43° 04' N	27° 46' E	518	350	J	0130, 0530, 0930, 1330, 1730, 2130	
	Croatia	Split	43° 30' N	16° 29' E	518	85	Q	0240, 0640, 1040, 1440, 1840, 2240	
	Cyprus	Cyprus	35° 03' N	33° 17' E	518	200	M	0200, 0600, 1000, 1400, 1800, 2200	
	Egypt	Alexandria		31° 12' N	29° 52' E	518	350	N	0210, 0610, 1010, 1410, 1810, 2210
		Serapeum		30° 28' N	32° 22' E	4209.5	400	X	0750, 1150
	France	Toulon		43° 06' N	05° 59' E	518	250	W	0340, 0740, 1340, 1540, 1940, 2340
						490	250	S	0300, 0700, 1100, 1500, 1900, 2300
	Greece	Heraklion		35° 20' N	25° 07' E	518	280	H	0110, 0510, 0910, 1310, 1710, 2110
		Corfu		39° 37' N	19° 55' E	518	280	K	0140, 0540, 0940, 1340, 1740, 2140
		Lemnos		39° 52' N	25° 04' E	518	280	L	0150, 0550, 0950, 1350, 1750, 2150
	Israel	Haifa		32° 49' N	35° 00' E	518	200	P	0020, 0420, 0820, 1220, 1620, 2020
	Italy	Rome		41° 48' N	12° 31' E	518	320	R	0250, 0650, 1050, 1450, 1850, 2250

NAV Area	Country	Station	Latitude	Longitude	Frequency (KHz)	Range (NM)	ID	Broadcast Times (UTC)
III	Italy	Augusta	37° 14' N	15° 14' E	518	320	V	0330, 0730, 1130, 1530, 1930, 2330
		Cagliari	39° 14' N	09° 14' E	518	320	T	0310, 0710, 1110, 1510, 1910, 2310
		Trieste	45° 41' N	13° 46' E	518	320	U	0320, 0720, 1120, 1520, 1920, 2320
	Malta	Malta	35° 49' N	14° 32' E	518	400	O	0220, 0620, 1020, 1420, 1820, 2220
	Russian Federation	Novosibirsk	44° 42' N	37° 44' E	518	300	A	0300, 0700, 1100, 1500, 1900, 2300
	Spain	Cabo de la Nao	38° 43' N	00° 09' E	518	300	X	0350, 0750, 1150, 1550, 1950, 2350
	Turkey	Istanbul	41° 04' N	28° 57' E	518	300	D	0030, 0430, 0830, 1230, 1630, 2030
		Samsun	41° 17' N	36° 20' E	518	300	E	0040, 0440, 0840, 1240, 1640, 2040
		Antalya	36° 53' N	30° 42' E	518	300	F	0050, 0450, 0850, 1250, 1650, 2050
	Ukraine	Izmir	38° 22' N	26° 36' E	518	300	I	0120, 0520, 0920, 1320, 1720, 2120
		Mariupol	47° 06' N	37° 33' E	518	280	B	0100, 0500, 0900, 1300, 1700, 2100
		Odessa	46° 29' N	30° 44' E	518	280	C	0230, 0630, 1030, 1430, 1830, 2230
Bermuda	Bermuda	32° 23' N	64° 41' W	518	280	B	0010, 0410, 0810, 1210, 1610, 2010	
IV	Canada	Riviere-au-Renard	50° 11' N	66° 07' W	518	300	C	0020, 0420, 0820, 1220, 1620, 2020
							D	0035, 0435, 0835, 1235, 1635, 2035
							H	0110, 0510, 0910, 1310, 1710, 2110
		Antalya	47° 30' N	52° 40' W	518	300	O	0220, 0620, 1020, 1420, 1820, 2220
		Thunder Bay	48° 25' N	89° 20' W	518	300	P	0230, 0630, 1030, 1430, 1830, 2230
		Sydney	46° 10' N	60° 00' W	518	300	Q	0240, 0640, 1040, 1440, 1840, 2240
	United States	Yarmouth	43° 45' N	66° 10' W	518	300	J	0255, 0655, 1055, 1455, 1855, 2255
							U	0320, 0720, 1120, 1520, 1920, 2320
							V	0335, 0735, 1135, 1535, 1935, 2335
	Labrador	53° 42' N	57° 01' W	518	300	X	0350, 0750, 1150, 1550, 1950, 2350	
	Iqaluit	63° 43' N	68° 33' W	518	300	T	0310, 0710, 1110, 1510, 1910, 2310	
	United States	Miami	25° 37' N	80° 23' W	518	240	S	0300, 0700, 1100, 1500, 1900, 2300
							A	0000, 0400, 0800, 1200, 1600, 2000
							F	0445, 0845, 1245, 1645, 2045, 0045
							G	0300, 0700, 1100, 1500, 1900, 2300
N							0130, 0530, 0930, 1330, 1730, 2130	
R							0200, 0600, 1000, 1400, 1800, 2200	
E							0040, 0440, 0840, 1240, 1640, 2040	
Antilles	Curaçao	12° 10' N	68° 52' W	518	400	H	0110, 0510, 0910, 1310, 1710, 2110	
VI	Argentina	Ushuaia	54° 48' S	68° 18' W	518	280	M	0200, 0600, 1000, 1400, 1800, 2200
		Rio Gallegos	51° 37' S	65° 03' W	518	280	N	0210, 0610, 1010, 1410, 1810, 2210
		Rivadavia	45° 51' S	67° 25' W	518	280	O	0220, 0620, 1020, 1420, 1820, 2220
		Blanca	38° 43' S	62° 06' W	518	280	P	0230, 0630, 1030, 1430, 1830, 2230
		Mar del Plata	38° 03' S	57° 32' W	518	280	Q	0240, 0640, 1040, 1440, 1840, 2240
	Buenos Aires	34° 36' S	58° 22' W	518	560	R	0250, 0650, 1050, 1450, 1850, 2250	
Uruguay	La Paloma	34° 40' S	54° 09' W	518	280	F	0050, 0450, 0850, 1250, 1650, 2050	
VII	South Africa	Walvis Bay	23° 03' S	14° 37' E	518	378	A	0000, 0400, 0800, 1200, 1600, 2000
							B	0010, 0410, 0810, 1210, 1610, 2010
							C	0020, 0420, 0820, 1220, 1620, 2020
							I	0120, 0520, 0920, 1320, 1720, 2120
India	Mumbai	19° 05' N	72° 50' E	518	250	O	0220, 0620, 1020, 1420, 1820, 2220	
						G	0100, 0500, 0900, 1300, 1700, 2100	
VIII	Madras	13° 08' N	80° 10' E	518	400	P	0230, 0630, 1030, 1430, 1830, 2230	

NAV Area	Country	Station	Latitude	Longitude	Frequency (KHz)	Range (NM)	ID	Broadcast Times (UTC)
VIII	Mauritius	Mauritius Station	20° 10' S	57° 28' E	518	400	C	0020, 0420, 0820, 1220, 1620, 2020
IX	Bahrain	Hamala	26° 09' N	50° 28' E	518	300	B	0010, 0410, 0810, 1210, 1610, 2010
	Egypt	Serapeum	30° 28' N	32° 22' E	518	200	X	0350, 0750, 1150, 1550, 1950, 2350
					4209.5	200	X	0750, 1150
		Quseir	26° 06' N	34° 17' E	518	400	V	0330, 0730, 1130, 1530, 1930, 2330
	Iran	Bushehr	28° 59' N	50° 50' E	518	300	A	0000, 0400, 0800, 1200, 1600, 2000
					518	300	F	0050, 0450, 0850, 1250, 1650, 2050
	Saudi Arabia	Jeddah	21° 23' N	39° 10' E	518	390	H	0705, 1305, 1905
	Oman	Muscat	23° 36' N	58° 30' E	518	270	M	0200, 0600, 1000, 1400, 1800, 2200
	Pakistan	Karachi	24° 51' N	67° 03' E	518	400	P	0230, 0630, 1030, 1430, 1830, 2230
	XI	China	Sanya	18° 14' N	109° 30' E	518	250	M
Guangzhou			23° 08' N	113° 32' E	518	250	N	0210, 0610, 1010, 1410, 2210
Fuzhou			26° 01' N	119° 18' E	518	250	O	0220, 0620, 1020, 1420, 2220
Shanghai			31° 08' N	121° 33' E	518	250	Q	0240, 0640, 1040, 1440, 2240
Dalian			38° 52' N	121° 31' E	518	250	R	0250, 0650, 1050, 1450, 2250
Indonesia		Jayapura	02° 31' S	140° 43' E	518	300	A	0000, 0400, 0800, 1200, 1600, 2000
		Ambon Island	03° 42' S	128° 12' E	518	300	B	0010, 0410, 0810, 1210, 1610, 2010
		Makassar	05° 06' S	119° 26' E	518	300	D	0030, 0430, 0830, 1230, 1830, 2030
		Jakarta	06° 06' S	106° 54' E	518	300	E	0040, 0440, 0840, 1240, 1640, 2040
Japan		Otaru	43° 19' N	140° 27' E	518	400	J	0130, 0530, 0930, 1330, 1730, 2130
		Kushiro	42° 57' N	144° 36' E	518	400	K	0140, 0540, 0940, 1340, 1740, 2140
		Yokohama	35° 14' N	139° 55' E	518	400	I	0120, 0520, 0920, 1320, 1720, 2120
		Moji	34° 01' N	130° 56' E	518	400	H	0110, 0510, 0910, 1310, 1710, 2110
		Naha	26° 05' N	127° 40' E	518	400	G	0100, 0500, 0900, 1300, 1700, 2100
Korea		Chukpy	37° 03' N	129° 26' E	518	200	V	0330, 0730, 1130, 1530, 1930, 2330
					490	200	J	0130, 0530, 0930, 1330, 1730, 2130
		Pyongyang	35° 36' N	126° 29' E	518	200	W	0340, 0740, 1340, 1540, 1940, 2340
					490	200	K	0140, 0540, 0940, 1340, 1740, 2140
Malaysia		Penang	05° 26' N	100° 24' E	518	350	U	0320, 0720, 1120, 1520, 1920, 2320
		Miri	04° 28' N	114° 01' E	518	350	T	0310, 0710, 1110, 1510, 1910, 2310
		Sandakan	05° 54' N	118° 00' E	518	350	S	0300, 0700, 1100, 1500, 1900, 2300
Singapore		Singapore	01° 25' N	103° 52' E	518	400	C	0020-0030, 0420-0430, 0820-0830, 1220-1230, 1620-1630, 2020-2030
Thailand		Bangkok	13° 43' N	100° 34' E	518	200	F	0050, 0450, 0850, 1250
United States		Guam	13° 29' N	144° 50' E	518	100	V	0100, 0500, 0900, 1300, 1700, 2100
Vietnam		Ho Chi Minh City	10° 47' N	106° 40' E	518	400	X	0350, 0750, 1150, 1550, 1950, 2350
					490	400	W	0340, 1540
		Haiphong	20° 44' N	106° 44' E	4209.5	400	W	0230, 0630, 1030, 1430, 1830, 2230
		Da Nang	16° 05' N	108° 13' E	518	400	K	0140, 0540, 0940, 1340, 1740, 2140
Taiwan		Kaohsiung	22° 29' N	120° 25' E	518	216	P	0230, 0630, 1030, 1430, 1830, 2230
International Maritime		Hong Kong	22° 13' N	114° 15' E	518	400	L	0150, 0550, 0950, 1350, 1750, 2150
XII	Canada	Prince Rupert	54° 20' N	130° 20' W	518	300	D	0030, 0430, 0830, 1230, 1630, 2030
		Tofino	48° 55' N	125° 35' W	518	300	H	0110, 0510, 0910, 1310, 1710, 2110
	United States	San Francisco	37° 55' N	122° 44' W	518	350	C	0400, 0800, 1200, 1600, 2000, 2400
		Kodiak	57° 46' N	152° 34' W	518	200	J	0300, 0700, 1100, 1500, 1900, 2300

NAV Area	Country	Station	Latitude	Longitude	Frequency (KHz)	Range (NM)	ID	Broadcast Times (UTC)
XII	Country	Honolulu	21° 22' N	158° 09' W	518	350	O	0040, 0440, 0840, 1240, 1640, 2040
		Wales	35° 31' N	121° 03' W	518	350	Q	0445, 0845, 1245, 1645, 2045, 0045
		Astoria	46° 10' N	123° 49' W	518	216	W	0130, 0530, 0930, 1330, 1730, 2130
XIII	Country	Holmsk	47° 02' N	142° 03' E	518	300	B	0010, 0410, 0810, 1210, 1610, 2010
		Murmansk	68° 46' N	32° 58' E	518	300	C	0020, 0420, 0820, 1220, 1620, 2020
		Arkhangelsk	64° 51' N	40° 17' E	518	300	F	0050, 0450, 0850, 1250, 1650, 2050
	Astrakhan	45° 47' N	47° 33' E	518	250	W	0340, 0740, 1140, 1540, 1940, 2340	
XV	Chile	Antofagasta	23° 40' S	70° 25' W	518	300	A	0400, 1200, 2000
							H	0000, 0800, 1600
		Valparaiso	32° 48' S	71° 29' W	518	300	B	0410, 1210, 2010
							I	0010, 0810, 1610
							C	0420, 1220, 2020
		Talcahuano	36° 42' S	73° 06' W	518	300	J	0020, 0820, 1620
		Montt	41° 30' S	72° 58' W	518	300	D	0430, 1230, 2030
							K	0030, 0830, 1630
		Punta Arenas	53° 09' S	70° 58' W	518	300	E	0440, 1240, 2040
							L	0040, 0840, 1640
Easter Island	27° 09' S	109° 25' W	518	300	F	0450, 1250, 2050		
					G	0050, 0850, 1650		
XVI	Peru	Paita	05° 05' S	81° 07' W	518	200	S	0300, 0700, 1100, 1500, 1900, 2300
		Callao	12° 03' S	77° 09' W	518	200	U	0320, 0720, 1120, 1520, 1920, 2320
		Mollendo	17° 01' S	72° 01' W	518	200	W	0340, 0740, 1140, 1540, 1940, 2340

China Domestic NAVTEX (486KHz) Chinese Service Station Broadcast Schedule

Coastal Station ID	NAVTEX Coastal Stations	Broadcast Time (UTC)	Broadcast Time (Beijing Time)
M	Sanya	00:00, 04:00, 08:00, 12:00, 16:00, 20:00,	00:00, 04:00, 08:00, 12:00, 16:00, 20:00,
N	Guangzhou	00:10, 04:10, 08:10, 12:10, 16:10, 20:10	00:10, 04:10, 08:10, 12:10, 16:10, 20:10
O	Fuzhou	00:20, 04:20, 08:20, 12:20, 16:20, 20:20	00:20, 04:20, 08:20, 12:20, 16:20, 20:20
Q	Shanghai	00:40, 04:40, 08:40, 12:40, 16:40, 20:40	00:40, 04:40, 08:40, 12:40, 16:40, 20:40
R	Dalian	00:50, 04:50, 08:20, 12:20, 16:20, 20:20	00:50, 04:50, 08:20, 12:20, 16:20, 20:20
T	Tianjin	00:30, 04:30, 08:30, 12:30, 16:30, 20:30,	00:30, 04:30, 08:30, 12:30, 16:30, 20:30,
Z	Zhanjiang	00:30, 04:30, 08:30, 12:30, 16:30, 20:30,	00:30, 04:30, 08:30, 12:30, 16:30, 20:30,

Updates and Maintenance

■ Diagnostics

The diagnostics test function allows you to understand the working status of the device. It includes the following steps:

Press the **[MENU]** key to enter the main menu display;

Press the **[▶]** key to select the **[Diagnostics]** submenu, and the screen will display as shown;

Press the **[▼]** key to enter the **[Diagnostics]** submenu, and press the **[▲]** **[▼]** keys to select items; Press the **[F2]** key to confirm entry.

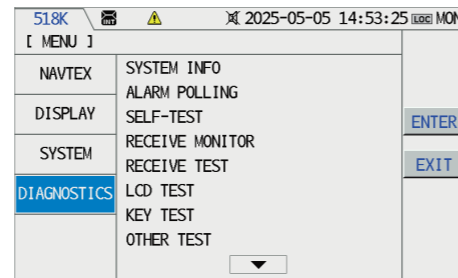

■ System Info

The device information screen allows you to view the basic information of the device.

Enter the **[Diagnostics]** submenu. Press the **[▼]** key to select **[System Info]**, and press the **[F2]** key to enter the device information display screen.

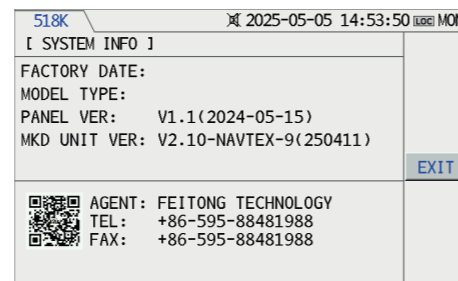

■ Alarm Polling

The alarm Polling screen can display the device's alarm time, status, and alarm description.

Enter the **[Diagnostics]** submenu, Press the **[▼]** key to select **[Alarm polling]**, Press the **[F2]** key to enter the alarm polling screen.

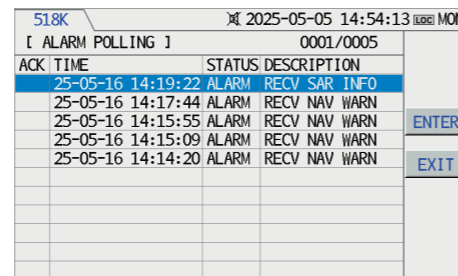

■ Self-Test

The device will automatically perform a series of self-tests after powering on, and the results can be displayed on the self-test display screen.

Enter the **[Diagnostics]** submenu, Press the **[▼]** key to select **[Self-test]**, Press the **[F2]** key to enter the self-test display screen.

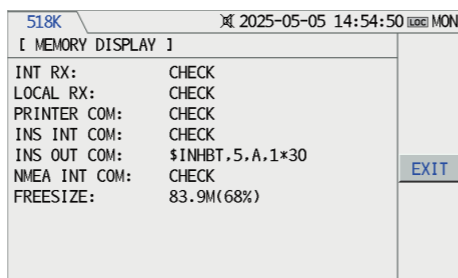

■ Reception Monitor

The reception monitoring screen can display the received characters of international and local channels in real-time.

Enter the **[Diagnostics]** submenu, Press the **[▼]** key to select **[Receive Monitoring]**, Press the **[F2]** key to enter the reception monitoring screen.

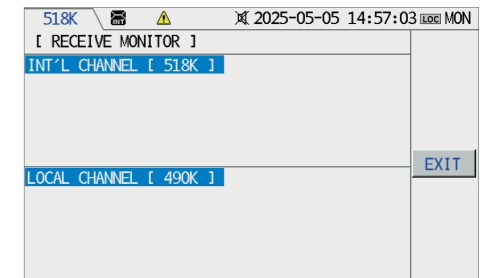

■ Reception Test

The reception test is mainly used to test whether the reception of international and local channels is normal. Enter the **[Diagnostics]** submenu, Press the **[▼]** key to select **[Receive Test]**;

Press the **[F2]** key to enter the reception test screen;

Press the **[F2]** key, the screen will display "SENDING" and the device will emit a beep sound. After the test is completed, the screen will display the reception information and test results.

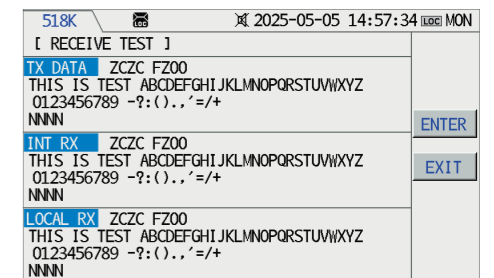

■ Screen Test

The LCD test is used to test the FT-7607 display Enter the **[Diagnostics]** submenu, press the **[▼]** key, select **[SCREEN]**, press the **[F2]** key to enter the LCD test screen, as shown below, press the **[◀]** **[▶]** keys to select the other three display screens.

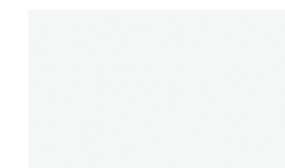

LCD test screen1



LCD test screen2



LCD test screen3



LCD test screen4

■ Printer Test

The printer test is mainly used to check if the printer is functioning properly. With the printer properly connected, enter the **[Diagnostics]** submenu, press the **[▼]** key, and select **[PRINTER TEST]**.

Press the **[F2]** key to enter the printer test screen, as shown.

Press the **[F2]** key, and the screen will display the prompt "PRINT MESSAGE? Yes/No". Press the **[◀]** key to select **YES**.

Press the **[F2]** key to confirm the print output. The screen will display "Printing test information" with the status bar icon

"" flashing. Once the printing is complete, the screen will display the print result: "Print successful", "Print failed", or "Printer not connected".

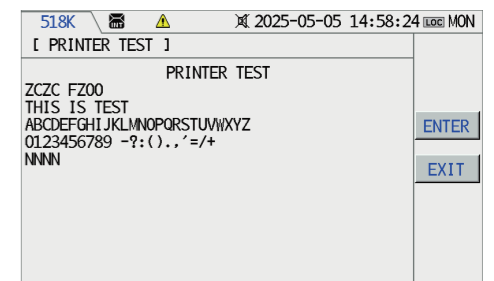

External Cleaning

If the device is dirty or dusty, wipe it with a soft, dry cloth.

Avoid using chemicals or alcohol, as they may damage the surface of the device.

Fuse Replacement

If the fuse is blown or the device stops working, the cause must be identified, and if possible, replace the fuse.

The fuse is located in the FUSE holder.

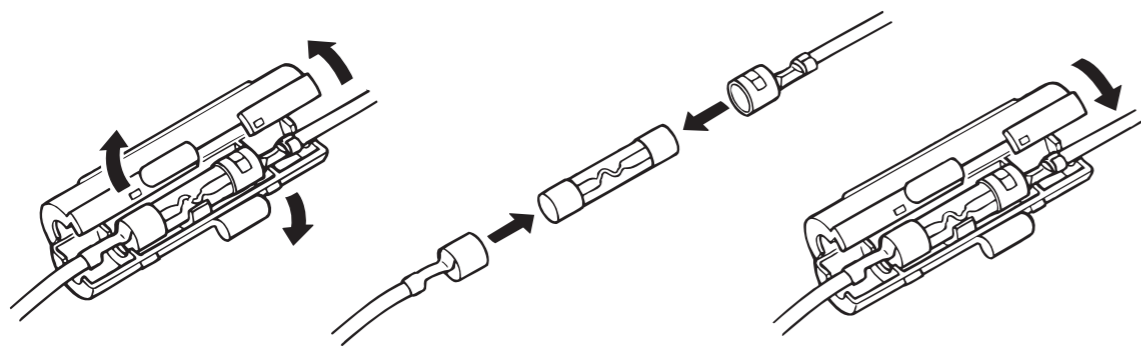

Troubleshooting

Power	
The power won't turn on.	Check if the power connector is securely connected. Check if the power polarity is reversed. Check if the fuse is damaged. Check if the power input exceeds the DC +36V. If normal operation cannot be restored, do not attempt to inspect the internal components of the equipment yourself.
Reception failure	
Unable to receive message	Check if the distance from the transmitting station exceeds 400 nautical miles. Check if the antenna cable is short-circuited or open-circuited. Check for strong signal interference, such as radar, radio, or other wireless signals. If unable to receive information (except for ABDL), check the reception settings.

安全提示

危险!

- 若有物品掉入设备或水溅入设备, 立即关闭配电板电源。(继续使用可能引发火灾或触电)
- 若设备冒烟或起火, 立即关闭配电板电源。(继续使用可能引发火灾或触电)
- 若设备运行异常, 立即关闭配电板电源。(继续使用可能引发火灾或触电, 建议联系代理商/经销商咨询)

警告!

- 开始安装前, 务必关闭配电板电源。(安装过程中通电可能引发火灾或触电)
- 仅使用指定电源线。(使用其他电缆可能引发火灾或触电)
- 请勿在设备可能被雨水或溅水打湿的位置安装。(水进入设备内部可能引发火灾或触电)

警告!

- 除非完全熟悉电气电路, 否则请勿在设备内部作业。
- 设备内部存在可能导致触电的危险电压。

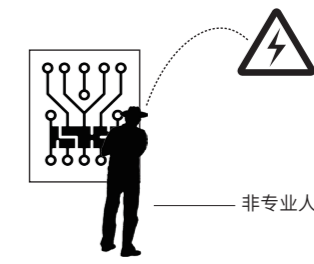

- 开始安装前, 请关闭主配电板上的电源。在开关附近张贴标志, 表明设备安装期间不应打开电源。如果设备安装期间电源未关闭或接通, 可能会导致火灾、触电或重伤。

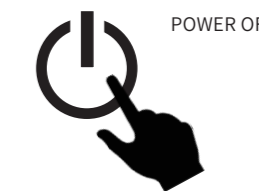

注意!

- 确认电源电压与设备的额定电压兼容。连接错误的电源可能会导致火灾或设备损坏。额定电压显示在显示单元背面的标签上。
- 小心使用接地铜带其边缘可能会伤到您的手。
- 请保持以下罗盘安全距离70MM以上。
- 接地设备: 未接地的设备可能会发出或收电磁干扰, 或导致触电。



目录

安全提示.....	34	■ 显示设置.....	50
前言.....	36	■ 系统设置.....	51
主要技术指标.....	36	系统接口规格说明.....	53-55
安装说明.....	37-40	■ 显示单元前视图说明.....	53
■ 系统连接图说明.....	37	■ 显示单元后视图说明.....	53
■ 显示单元安装示意图.....	38	NAVTEX系统.....	56-62
■ 天线安装.....	40	■ NAVTEX简介.....	56
整机说明.....	41-43	■ NAVTEX原理.....	57
■ 主机部分.....	41	■ NAVTEX信息格式.....	58
■ 面板布局.....	43	■ 全球NAVTEX台站信息列表.....	59
主要功能说明.....	44	■ 中国国内NATEX(486KHz) 中文业务台站广播时间表.....	62
■ 信息接收.....	44	更新与维护.....	63-66
■ 信息存储.....	44	■ 诊断测试.....	63
■ 显示功能.....	44	■ 本机资料显示.....	63
■ 自检功能.....	44	■ 报警信息查询.....	63
■ 报警功能.....	44	■ 系统自检显示.....	64
■ 打印功能.....	44	■ 接收信息监控.....	64
基本功能操作说明.....	45-52	■ 接收信息测试.....	64
■ 电源开关.....	45	■ 屏幕测试.....	65
■ 亮度设置.....	45	■ 打印机测试.....	65
■ 频道列表选择.....	45	■ 清洗外观.....	66
■ 信息列表类型选择.....	45	■ 置换保险丝.....	66
■ 信息加锁保护.....	45	■ 疑难解答.....	66
■ 信息阅览、打印与数据输出.....	45		
■ 报警查询及确认.....	46		
■ 接收设置.....	46		

前言

感谢您选用本公司研制的产品,型号:FT-7607 名称:航行警告NAVTEX接收机。产品包括主机以及随机配置附件,请参看产品《装箱清单表》。在安装使用产品前,请务必仔细阅读《产品使用说明书》,避免人员不专业、错误操作引起设备损坏或人身安全,本公司不承担由此引起的一切后果责任。

※注:若产品升级更新导致《产品使用说明书》与设备实际操作使用不一致,请以设备为准。

主要技术指标

项目名称	技术参数
接收频率	518KHz、490KHz、486KHz、4209.5KHz
接收灵敏度	<4% (2μV e.m.f, 50Ω)
存储容量	>600条(平均长度:512字符)
接收类型	F1B
显示单元	7"LCD、9"LCD、12.2"LCD
电源	DC12V~36V
罗经安全距离	70cm

安装说明

■ 系统连接图说明

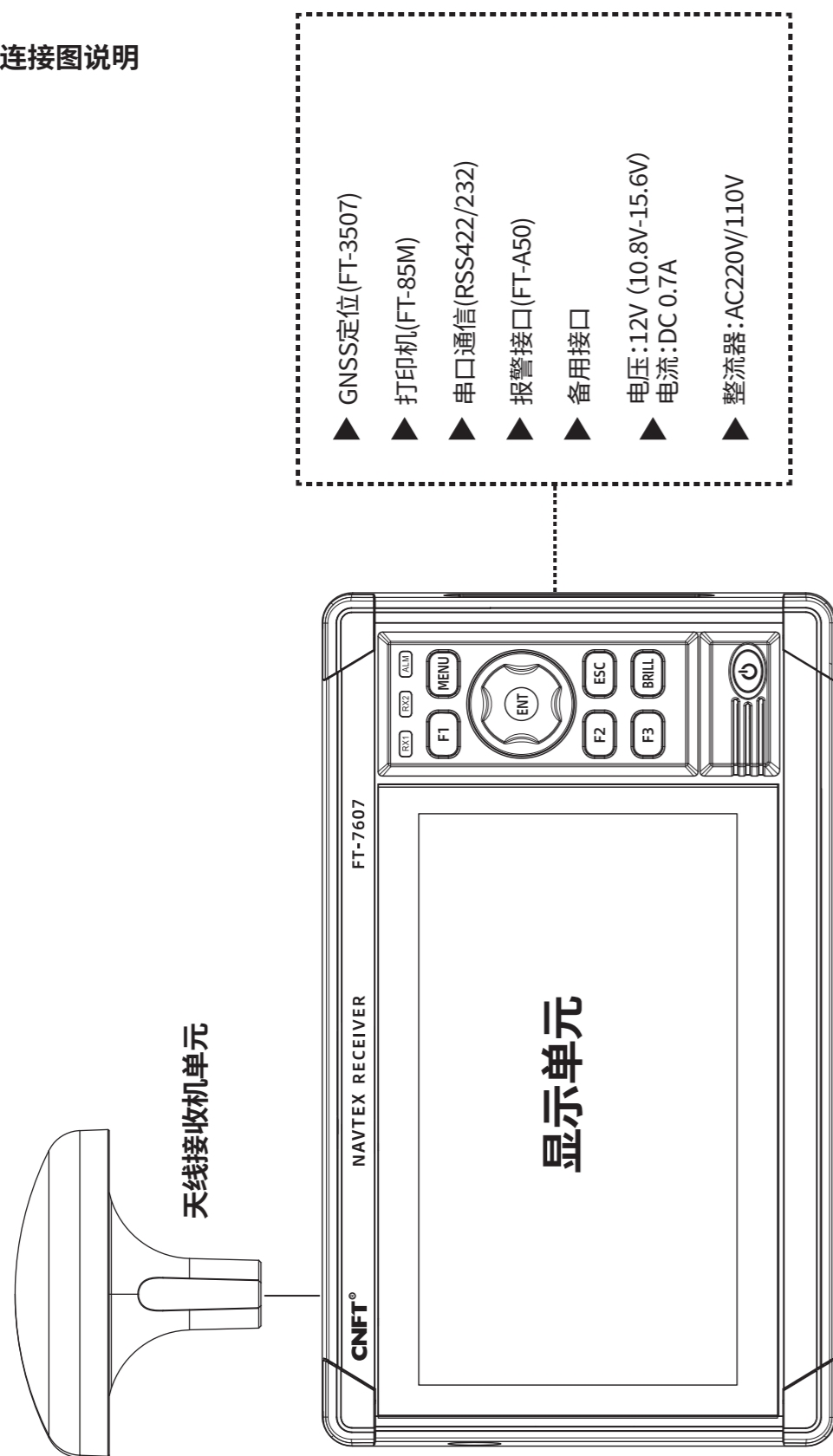

- ▲ GNSS定位(FT-3507)
- ▲ 打印机(FT-85M)
- ▲ 串口通信(RSS422/232)
- ▲ 报警接口(FT-A50)
- ▲ 备用接口
- ▲ 电压:12V (10.8V-15.6V)
电流:DC 0.7A
- ▲ 整流器:AC220V/110V

..... 选配或用户提供
—— 标配

■ 显示单元安装示意图

主机单元支架类型

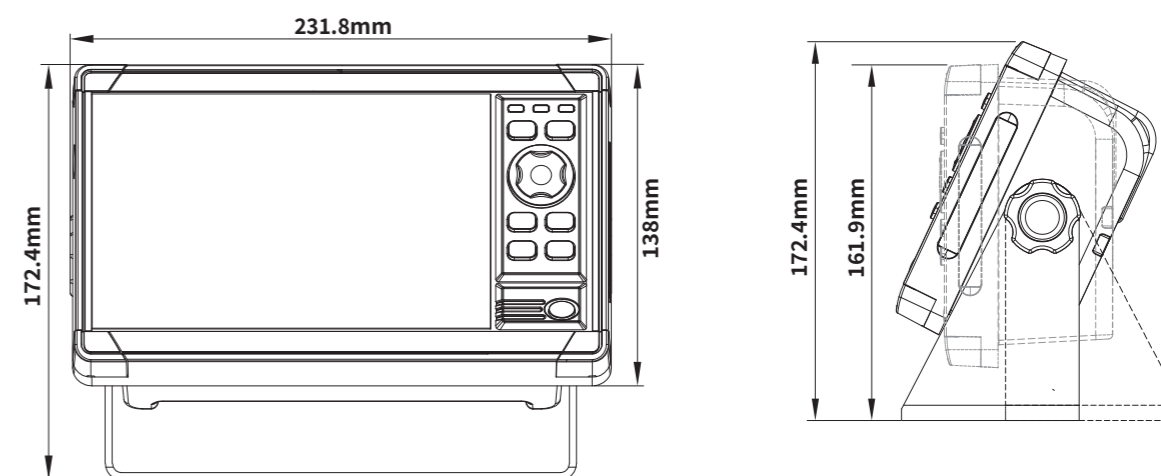

嵌入式类型

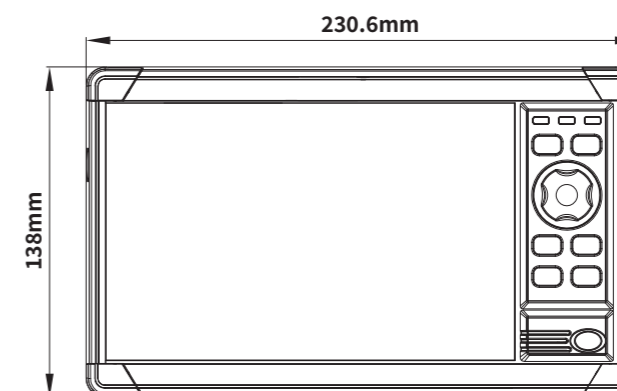

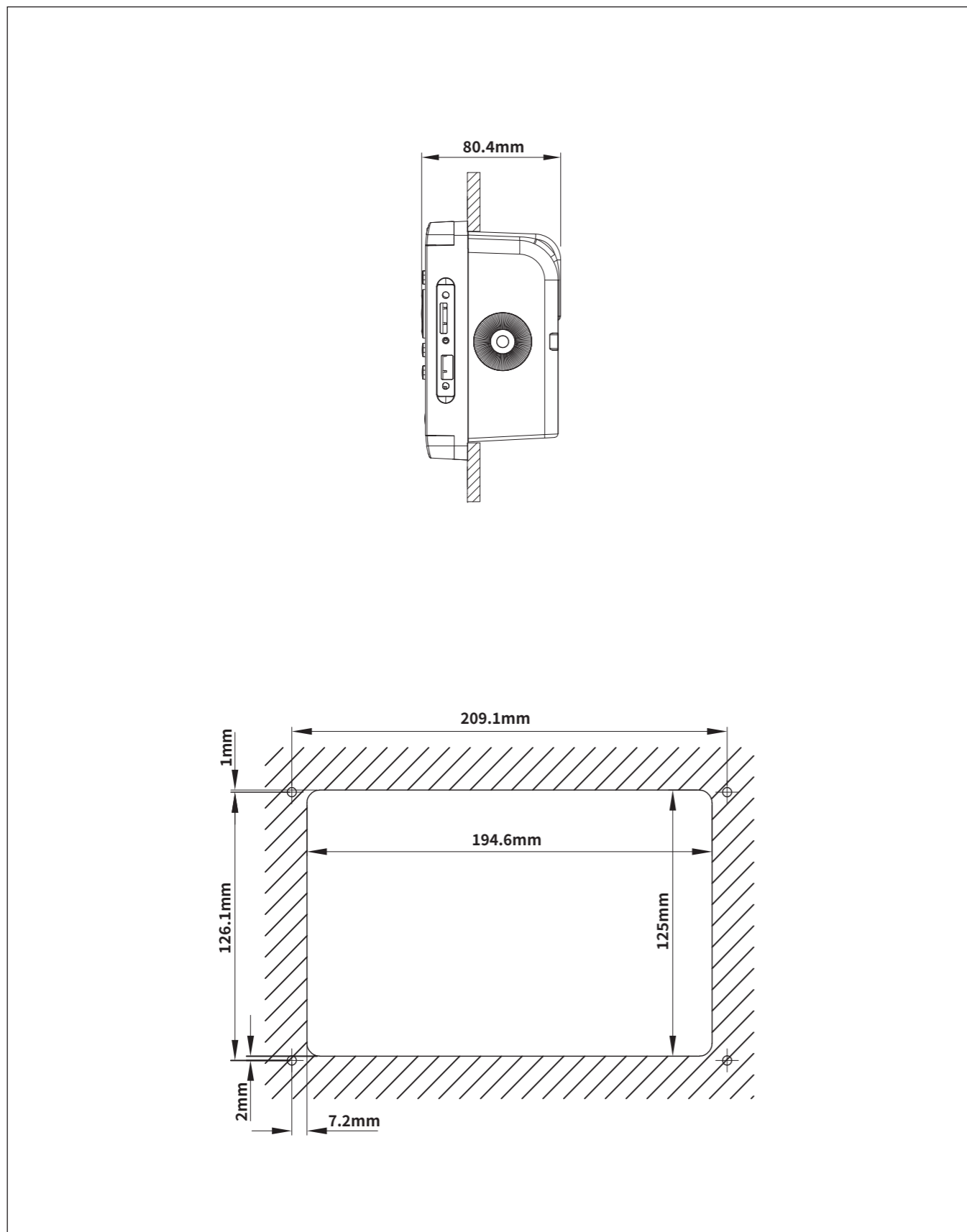

■ 天线安装

天线安装十分重要,合理的架设可减少干扰,使接收距离达到最佳,安装时请注意以下几点:

1. 天线应架设在垂直位置上,在水平面上应尽量远离导电物体,最小距离应超过0.5米,天线不能靠近大型的垂直物体,应尽量保持360°无阻挡。
2. 天线应尽量远离大功率发射源,如雷达、电台或其他无线电天线,最好离开3米以上。
3. 天线电缆远离电源电缆,如与电缆交叉应保持90度垂直。
4. 天线射频电缆随机提供RG-58电缆,一端已与天线放大器相连,另一端接收机主单元。

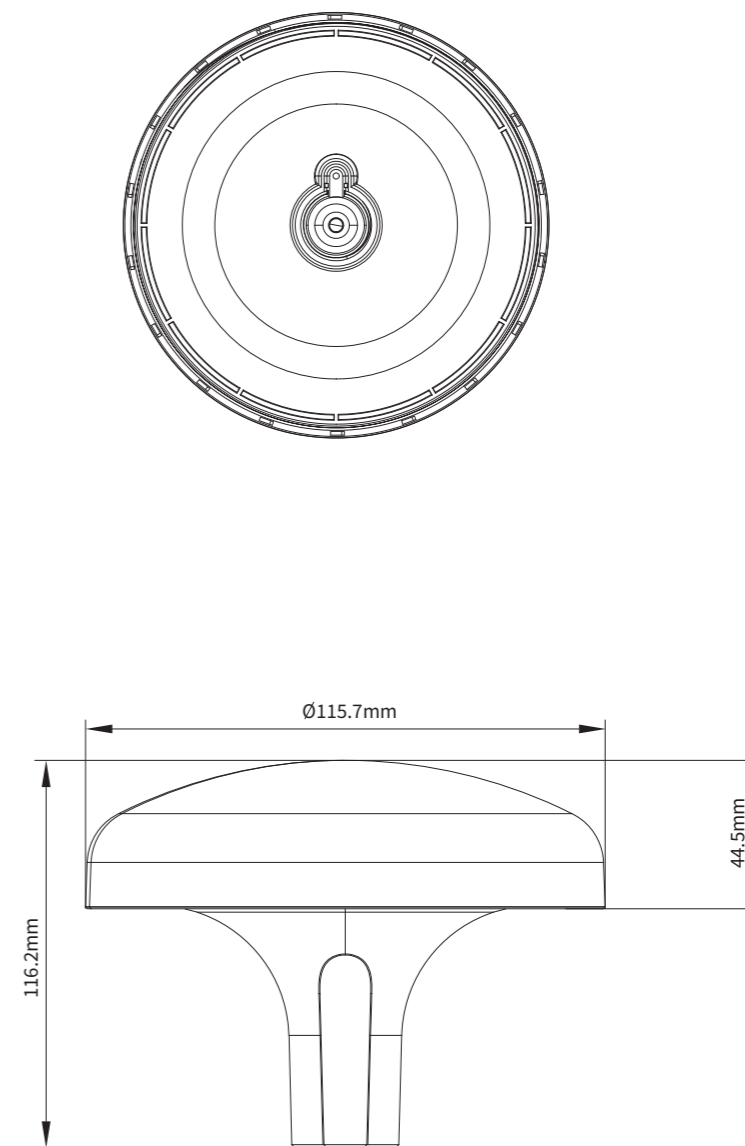

整机说明

主机部分

面板说明

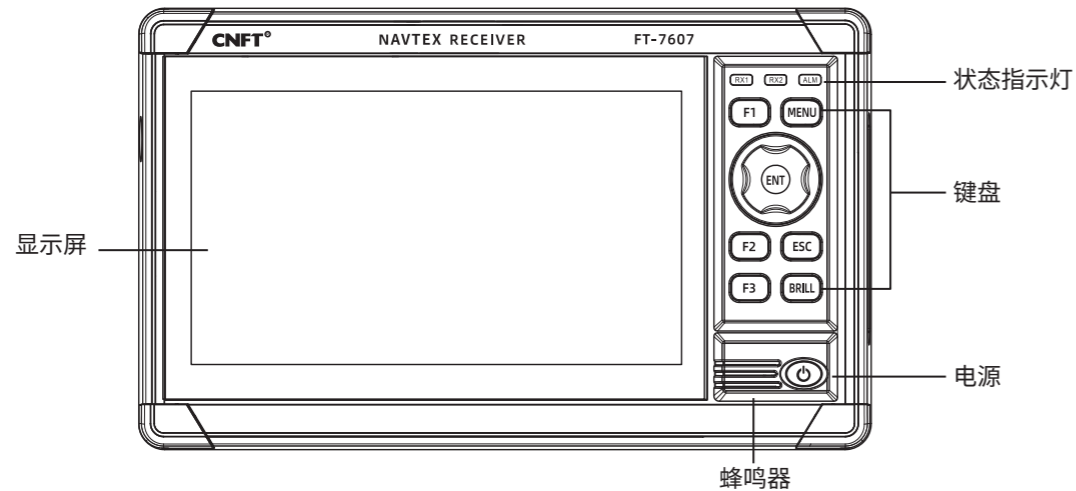

状态指示灯:

RX1	国际频道接收指示, 长亮时处于接收信息, 闪亮为该频道列表中有未读信息
RX2	当地频道接收指示, 长亮时处于接收信息, 闪亮为该频道列表中有未读信息
ALM	报警指示, 闪亮表示处于报警状态

键盘:

[▲][▼][◀][▶]	用于移动光标或选择操作
F1 F2 F3	对应显示屏上功能
ENT	用于确认菜单功能
MENU	用于进入主菜单
ESC	用于取消操作或退出主菜单
BRILL	进入亮度设置
⏻	用于开关机器电源

信息接收说明

FT-7607航行警告接收机用于接收518K(国际频道)和486K/490K/4209.5K(国内频道的海上安全广播信息), 接收到的信息可通过LCD显示或专用打印机打印。当机器收到信息广播信号时, 屏幕状态档“”、“”闪动或面板 RX1、RX2 指示灯亮, 此时机器处于接收信息中, 信息接收完毕后, 机器发出“嘀、嘀”两声提示音, 在信息列表中会自动增加一行信息标题, 屏幕状态栏“”、“”或面板 RX1、RX2 指示灯闪动, 表明有新信息没有查看, 如果报警允许, 机器即发出报警提示音。

列表图面

当前频率列表: 518K或486K/490K/4209.5K 列表的信息总数

当前列表类型: [全部信息列表] 5 条信息

信息标题	001 保留未用	FZ00	2024-08-05 11:29:47	
光标选择	002 航行警告	GA81	2024-08-01 17:14:05	
	003 航行警告	GA87	2024-08-01 17:09:59	
	004 航行警告	GA01	2024-08-01 17:08:49	
	005 航行警告	GA63	2024-08-01 14:17:22	

外接航行数据显示: 航向: 42.0° 对地船速: 0.0kt 横倾: 0.0° (T)
纬度: N 24° 46.3550 经度: E 118° 41.9720

功能键提示: 返回, 列表, 频道, 菜单

未读信息标识

功能键提示

	国际频道正在接收信息		已连接打印机
	当地频道正在接收信息		正在打印输出
	国际频道有未读信息		打印信息时出错
	国内频道有未读信息		报警音开启状态
	处于报警状态		报警音关闭状态

信息阅览图面

当前信息类型: 486K 时间: 2024-08-05 09:22:29

信息列表编号: 航行警告 2024-01-17 10:58:34 误码率: 0.0%

信息的起始符: ZCZC 0A52 福州海岸电台

信息内容: N/W XSG NR109 CK79/64 16 1602
闽航警(52/23)台湾海峡(2023)年(11)月(15)日至(2024)年(03)月(15)日每日(24)小时在以下四点连线范围内的安全作业区进行采砂作业(24-12.16N118-24.02E)
(24-10.15N118-26.18E)(24-08.10N118-24.03E)(24-10.11N118-21.46E)无关船舶禁止驶入

信息结束符: NNNN

功能键提示: 返回, 输出, 打印, 菜单

信息安符错误比例

信息识别符 (B1B2B3B4)
B1 是岸台标识字母
B2 是信息类型的标识字母
B3B4 是信息编号

■ 面板布局

显示单元前视图说明

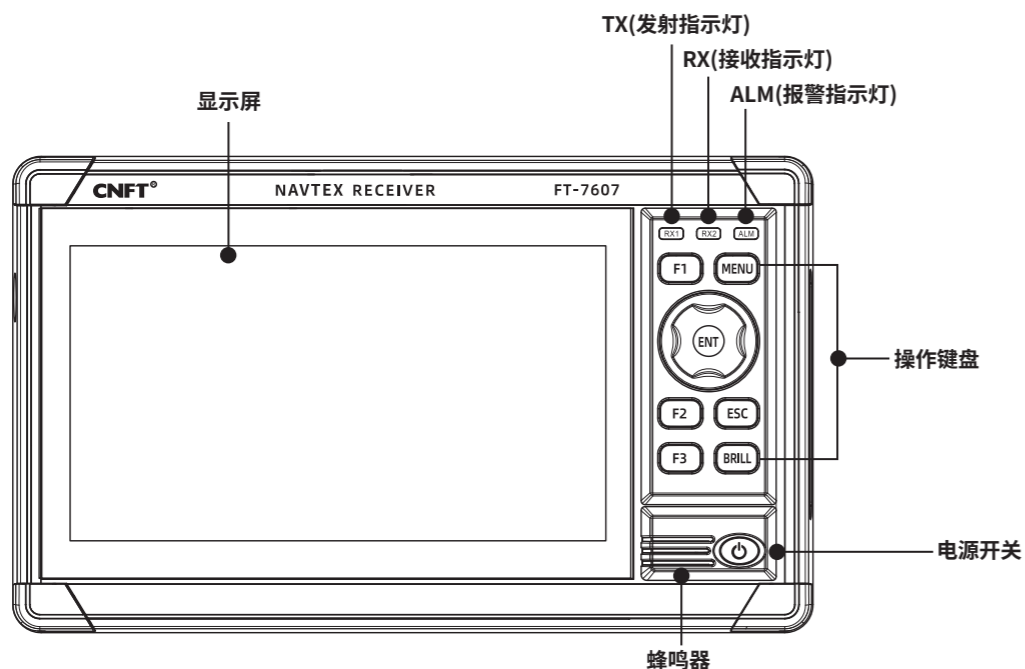

显示单元后视图说明

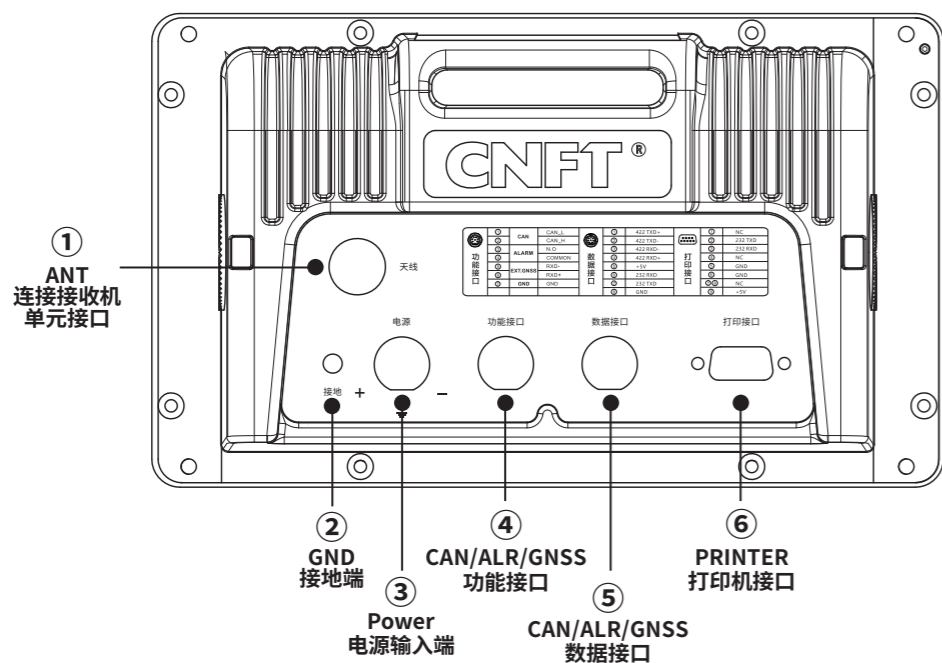

主要功能说明

■ 信息接收

- 双频道同时接收处理信息
- 中/英文信息接收
- 与定相信号同步后, 自动接收处理信息
- 接收误码率超过33%时, 该信息将被拒收
- 接收模式选择, 可按自动、手动和内部导航选择
- 可按设置的接收台站信息类型进行接收, ABDL类信息除外

■ 信息存储

- 信息接收误码率低于33%时, 信息将被自动保存
- 两次接收同样的信息自动保存误码率低的一次
- 每个接收机可存储256条平均长度为2000字符的信息
- 能存储个别长度达到8000个字符的信息
- 当接收信息超过256条时, 自动清除最早的信息(保护信息除外)
- 信息存储时间为60-70小时, 72小时后自动删除(含关机时间)
- 锁定信息和信息编号为00的信息将永久保存

■ 显示功能

- 信息电文显示, 错误字符显示为“*”符号
- 可显示16行信息文本, 每行32个字符
- 在外接GPS输入时可显示航行数据, 如位置、速度、方向等
- 可按全部、报警、用户选择、完整、自定义信息列表显示信息标题
- 日期时间及操作提示显示

■ 自检功能

- 系统自检功能
- 接收测试等功能

■ 报警功能

- 具有声光报警, 报警输出音量高达75dBA
- 可通过报警声分辨出紧急、告警、气象或一般信息的接收
- 可选择信息类型进行报警
- 具有报警记录查询及输出开关功能

■ 打印功能

- 可自动或手动选择信息进行打印
- 可对选择接收台站及信息类型进行自动打印

基本功能操作说明



■ 电源开关

机器连接电源,按  键开机,按3秒  键关机。

■ 亮度设置

按  键进入调节状态,按[◀][▶]键,可调节屏幕亮度,按[▼]键,再按[◀][▶]键,可调节按键亮度,按[▼]键,再按[◀][▶]键,可显示模式。



■ 频道列表选择

在信息列表图面,先按  键切换快捷按键功能,再按  可切换列表,  切换频道,支持触屏操控,屏幕左上角显示对应的频道:518K或490K(486K)/4209.5K,此时列表中显示该频道接收的信息标题。

■ 信息列表类型选择

在信息列表图面,按  键,可依次在全部、报警、用户选择、完整、自定义信息列表之间选择。自定义信息列表可在显示设置菜单中的信息列表选择:紧急、气象、未读或加锁。



■ 信息加锁保护

在列表图面,按  键,可对当前光标处的信息进行加、去锁保护,  表示该条信息被加锁,该信息将不会在72小时后被自动删除。





■ 信息阅览、打印与数据输出

在信息列表图面,按  键,可显示当前光标处的信息电文内容,屏幕进入信息显示图面。

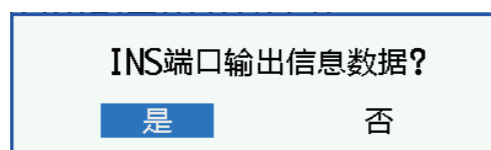
按 [▲][▼] 键,阅览信息电文,按[◀][▶]键,选择上一条或下一条信息。



按  键,屏幕显示“是/否INS端口输出当前信息数据?”提示,按[◀]键,选择  ,再按  键确认数据输出,这时机器通过INS接口输出当前信息的数据。

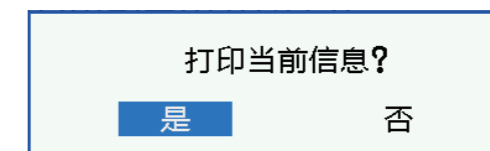

按  键,屏幕显示“是/否打印当前信息?”的提示框,按[◀]键,选择  ,再按  键确认打印信息,屏幕  图标,这时机器通过打印接口输出打印信息给打印。



■ 报警查询及确认

按  键,进入主菜单显示;按[▼]键,选择[诊断测试]子菜单;按[▶]键,选择[2.报警查询];按  键,进入报警查询图面;按[▲][▼]键,选择报警信息行;按  键,确认报警信息。

※注:如报警查询画面中的报警信息全都被确认后,报警输出及指示灯自动取消。

■ 接收设置

按  键,进入主菜单显示;按[▼]键,选择[接收设置]子菜单;

按[▶]键,进入子菜单;按[▲][▼]键,选择项目;

按[◀][▶]键,修改设置,或  键进入对应项目编辑设置。

486K  2024-08-05 09:54:58 周一		
[主菜单]		
接收设置	接收模式: 自动 本地频道: 486kHz	
显示设置	接收提示: 开	
系统设置	自动打印: 关 台站列表编辑	进入
诊断测试	接收台站与信息类型编辑 用户选择台站与信息类型编辑 自动打印台站与信息类型编辑 INS输出台站与信息类型编辑	返回

◇ 接收模式设置

该选项可设置为:自动/手动/内部导航系统,用于选择机器接收NAVTEX信息的方式。

自动模式:当有效外接航行数据输入时,机器自动根据发射台站的范围进行判断接收,没有航行数据输入时,机器即对全部发射台站进行接收。

手动模式:机器按照用户选择的台站与信息类型进行接收。

内部导航系统模式:机器按照INS输入的台站与信息类型进行接收。

◇ 本地频道设置

该选项可设置为:490KHz(486KHz)/4209.5KHz,用于选择机器本地频道的工作频率,486KHz为中国的NAVTEX的中文信息业务频道,机器可接收中文信息。

◇ 接收提示开关

该选项可设置为:开/关,用于是否提示显示新信息,当设置处于开启时,只要接收到一条新信息,屏幕显示“是/否显示新信息?”提示,这时可以选择是/否显示该信息电文。

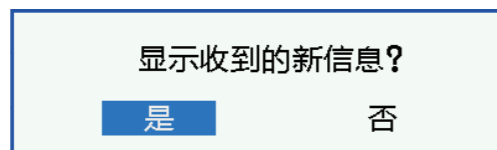

◇ 自动打印选择

该选项可设置为:关/全部/用户选择,用于选择接收到某些信息会自动打印信息。

全部:只要接收到一条新信息,机器既自动打印输出。

用户选择:只有接收到用户选择的台站与信息类型的信息,机器才会自己打印输出,否则不打印输出。

◇ 台站列表编辑

该选项用于设置全球16个航行区的台站信息,每个航行区可设置32个台站信息信息包括:台站名称、台站坐标、台站发射频道的识别符(B1)和作用范围。

编辑台站信息操作:按 [菜单] 键,进入主菜单显示;

按 [▶] 键,选择 [接收设置] 子菜单;

按 [▼] 键,选择 [台站列表编辑];

按 [F2] 键,进入 [台站列表编辑] 画面;如图。

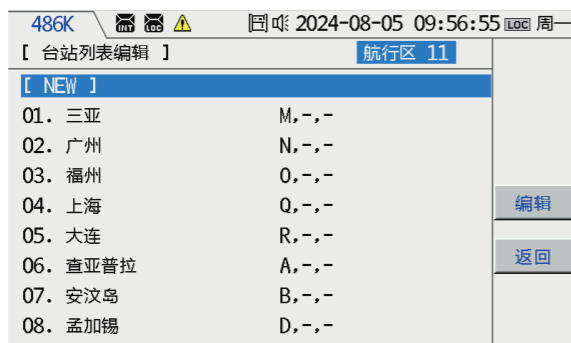

按 [◀] [▶] 键,选择航行区(01-16);按 [▲] [▼] 键,选择台站或 [NEW] 新增加,按 [F2] 键,进入编辑台站信息编辑画面,按 [▲] [▼] 键,选择台站信息项目,选择“编辑”修改台站信息参数,编辑完毕后按 [F2] 键,按 [▼] 选择“保存设置?”按 [返回] 键,屏幕显示“是/否保存台站信息设置?”的提示,按 [◀] 键,选择 [是],按 [F2] 键,确认保存该设置。



删除台站信息操作:进入 [台站列表编辑] 画面,按 [▲] [▼] 键,选择台站,按 [F3] 键,屏幕显示“是/否删除选择台站?”提示,按 [◀] 键,选择 [是],按 [F2] 键,确认删除该台站。

※注: 不要随意删除台站信息,否则会影响自动接收模式的接收判断,造成不会接上信息。



◇ 接收台站与信息类型设置

机器的接收模式设置为:手动时,机器即根据接收台站与信息类型的设置进行接收,可利用这该功能进行台站信息的选择接收。

按 [菜单] 键,进入主菜单显示;按 [▶] 键,选择 [接收设置] 子菜单;按 [▼] 键,选择 [接收台站与信息类型编辑];

按 [F2] 键,进入 [接收台站与信息类型编辑] 画面。

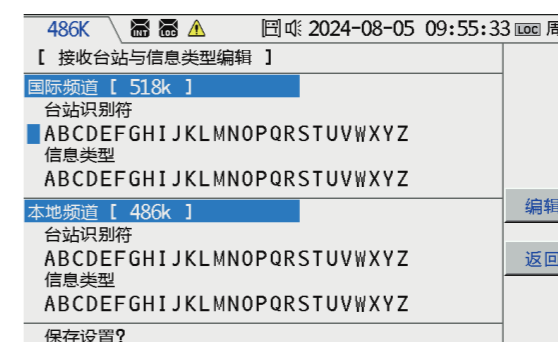

按[▲][▼]键,选择项目,按[◀][▶]键,选择要修改位置的[**台站或信息类型**],选择设置后,按[▲][▼]键修改。

按[▼]键,选择“保存设置?”,按[F2]键,屏幕显示“是/否保存接收台站设置?”提示;

按[◀]键,选择 **是**,按[F2]键,确定保存设置。

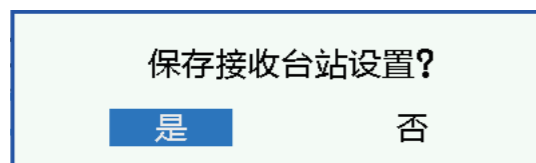

◇ 用户选择台站与信息类型设置

该项可设置用户选择的台站与信息类型,当机器的[**信息列表**]、[**自动打印**]、[**报警信息**]选择为用户选择时,机器即按该

设置进行识别处理信息。按[菜单]键,进入主菜单显示;按[▶]键,选择子菜单[**接收设置**]子菜单;

按[▼]键,选择[**用户选择台站与信息类型编辑**];按[F2]键,进入[**用户选择台站与信息类型编辑**]图面。

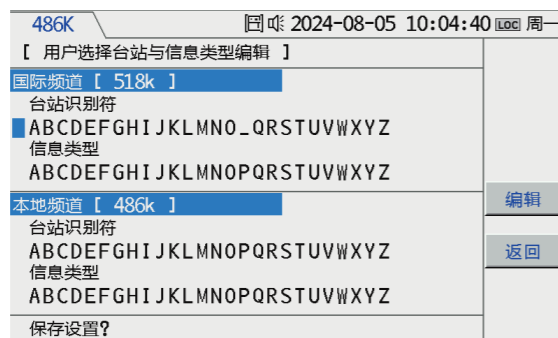

按[▲][▼]键,选择项目,按[◀][▶]键,选择要修改位置[**台站或信息类型**],按[▲][▼]键进行修改。

选择设置后,按[▼]键,选择“保存设置?”,按[F2]键,屏幕显示“是/否保存用户选择设置?”提示;

按[◀]键,选择 **是**,按[F2]键,确定保存设置。

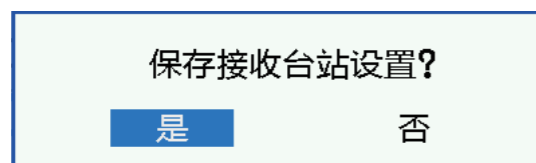

■ 显示设置

按[菜单]键,进入主菜单显示,按[▲][▼]键选中显示设置;

按[▶]键,选择[**显示设置**]子菜单;

按[▼]键,进入子菜单,屏幕显示如图;

按[▲][▼]键,选择项目;

按[◀][▶]键,修改设置。

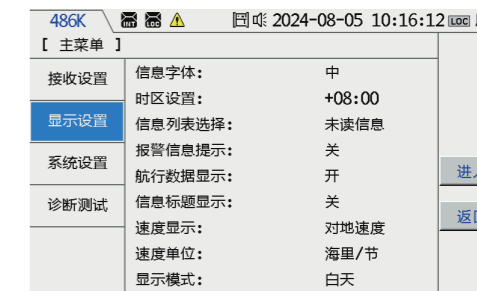

◇ 信息字体选择

该选项可设置为:小/中/大,用于选择英文信息字符的显示字体,

小字体(6×9)、中字体(7×14)、大字体(14×22),中文信息显示字体不受控制,默认为(16×16)。

◇ 时区设置

用于设置时差(北京时差为+08:00),机器屏幕上的当前时间按时差设置显示。

◇ 信息列表选择

该选项可设置为:紧急信息、气象信息、未读信息、加锁信息,用于没自定义信息列表的一个选择。

◇ 报警信息提示开关

该选项可设置为:开/关,当设置为开启时,只要有报警启动,机器屏幕会显示如图报警提示框,然后按任何键可确认解除报警。



◇ 航行数据显示开关

该选项可设置为:开/关,用于控制信息列表画面上的“航行数据显示框”的显示。

◇ 信息标题显示开关

该选项可设置为:开/关,当设置为开启时,信息内容查看时,在信息标题内会显示出该信息接收时的位置坐标及距离发射台站的距离。

◇ 速度显示选择

该选项可设置为:对地速度/对水速度,用于选择航行数据显示框中速度的类型。

◇ 速度单位选择

该选项可设置为:海里/节、公里/时、英里/时,用于选择速度的单位。

◇ 显示模式

该选项可设置为:白天/夜间,更改屏幕显示模式。

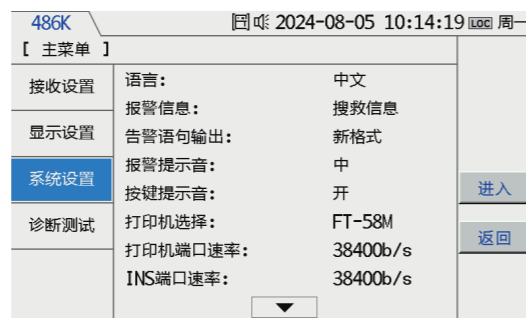

■ 系统设置

按 [菜单] 键,进入主菜单显示,按[▲][▼]键选中系统设置;按[▶]键,选择[系统设置]子菜单;

按[▼]键,进入子菜单,屏幕显示如图;

按[▲][▼]键,可选择项目;按[◀][▶]键,可修改设置。

◇ 语言选择

该选项可设置为:中文/ENGLISH(英文),用于改变除信息内容外的屏幕显示文字。

◇ 报警信息选择

该选项可设置为:搜救信息/警告信息/用户选择/全部,用于选择报警信息的类型,允许接收到该信息类型的信息可进行声音报警提示。**机器2秒钟发出如下重复音:**

- 1.搜救信息发出 (---)
- 2.搜救信息发出 (---)
- 3.搜救信息发出 (— —)
- 4.搜救信息发出 (— — —)

◇ 报警提示音选择

该选项可设置为:关/小/中/大,用于设置报警时提示音音量。

◇ 按键提示音开关

该选项可设置为:开/关,用于控制操作按键时的提示音,有效键音为“嘀”,无效键音为“嘟”。

◇ 打印机选择

该选项可设置为:FT-58M/DPU-414,用于选择可连接的打印机的型号。

◇ INS端口速率设置

该选项可设置为:4800b/s、9600 b/s、19200 b/s及38400 b/s,用于选择INS端口输入/输出数据的波特率。

◇ 打印机端口速率设置

该选项可设置为:4800b/s、9600b/s、19200b/s及38400b/s,用于选择打印机端口波特率。

◇ NMEA输入端口速率设置

该选项可设置为:4800b/s、9600b/s、19200b/s及38400b/s,用于设置NMEA输入端口数据的波特率。

◇ 时间日期设置

按 [菜单] 键,进入主菜单显示;

按[▶]键,选择[系统设置]子菜单;

按[▼]键,选择[时间日期设置];

按 [F2] 键,进入时间日期设置状态,屏幕显示如图。

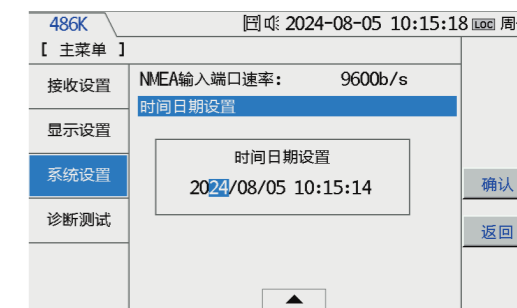

按[◀][▶]键,选择修改年/月/日/时/分/星期;

按[▲][▼]键,修改时间,按 [F2] 键,屏幕显示“是/否更新内部时钟?”提示,按[◀]键,选择 **是**,按 [F2] 键确认更新内部时钟,这时时间日期设置成功。

※注: 为保证时间源的同步,时间日期设置,请按国际时间进行设置。



系统接口规格说明

■ 显示单元前视图说明

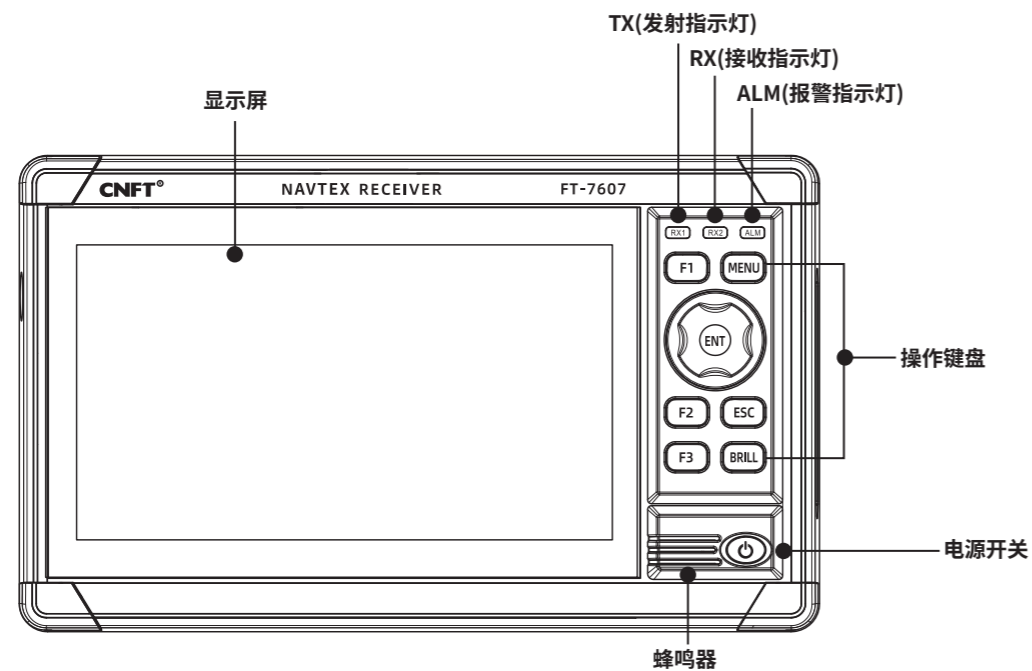

■ 显示单元后视图说明

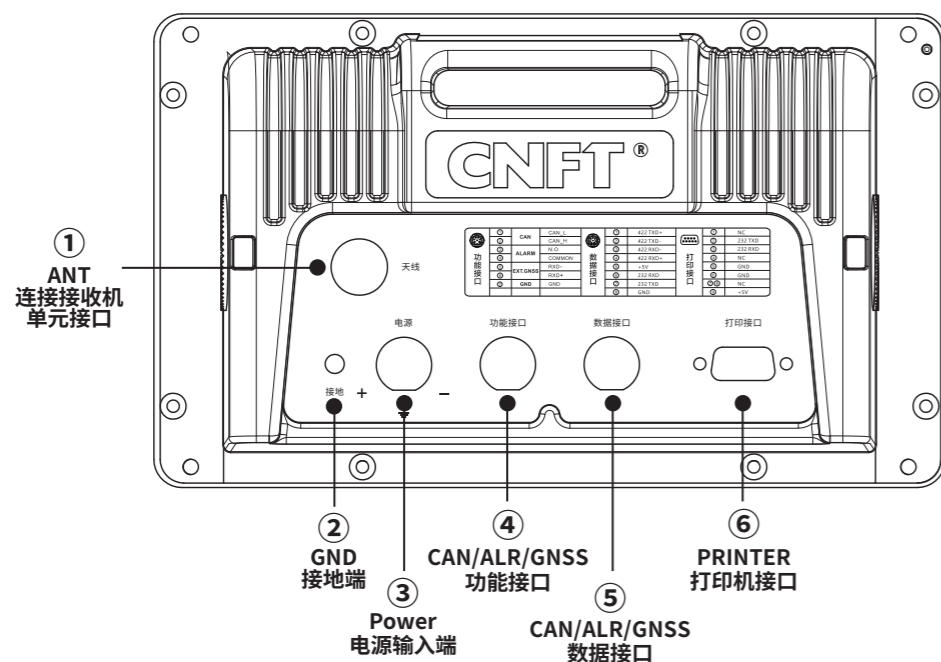

显示单元后视接口规格

- ① ANT(连接室外接收机单元专用接口)
- ② GND (总接地端)

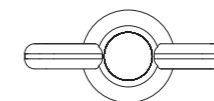

- ③ POWER(电源输入端 12V (10.8V-15.6V))

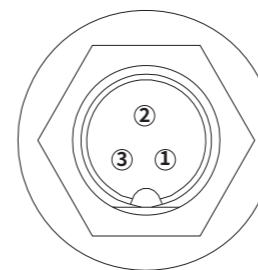

- 1: 电源输入负极端(-)
- 2: GND 接地端
- 3: 电源输入正极端(+)

- ④ CAN/ALR/GNSS(功能接口)

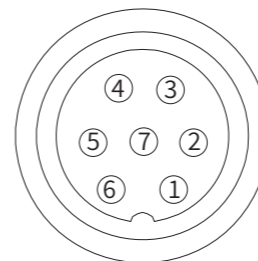

序号	定义	功能
1	CAN_L	CAN通信接口L
2	CAN_H	CAN通信接口H
3	N.O	报警接口常开端
4	COMMON	报警接口公开端
5	RXD-	GNSS定位输入-
6	RXD+	GNSS定位输入+
7	GND	地

⑤ INS/BAM(数据接口)

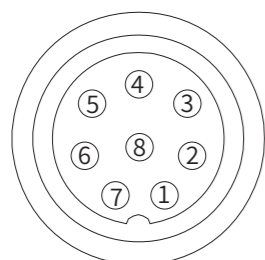

序号	定义	功能
1	TX_422+	422串口输出+
2	TX_422-	422串口输出-
3	RX_422-	422串口输入-
4	RX_422+	422串口输入+
5	+5V	DC 5V、200mA
6	RX_232	232串口输入
7	TX_232	232串口输出
8	GND	地

⑥ PRINTER(打印机接口)

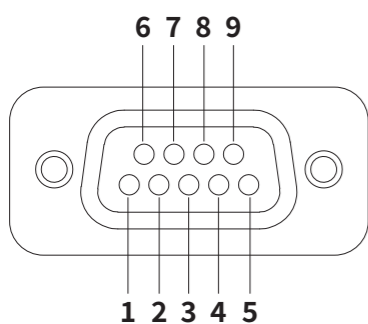

序号	定义	功能
1	NC	空
2	PRT TXD	数据输出
3	PRT RXD	数据输入
4	NC	空
5	GND	接地
6	GND	接地
7	RES	复位
8	SCK	时钟
9	+5V	电源输出

NAVTEX系统

NAVTEX简介

NAVTEX 是“航行警告电传电报”的英文简称,是采用无线电传直接印字电报方式进行收发通信的海上专用业务系统。通过该业务,船舶可以从海岸电台的广播中自动接收到诸如搜救信息、航行警告、气象警告、气象预报及其他紧急信息等海上安全信息。该业务为海上航行船舶提供一种便捷、自动地获得海上安全信息的有效手段。

NAVTEX 是全球航行警告业务的一个组成部分(World-Wide Navigational Warning Service, 简称 WNWNS)。全球 NAVTEX 业务和 INMARSAT 系统的安全通信网业务共同组成了GMDSS 海上安全信息播发系统。NAVTEX 信息在国际通用的 518KHz 频率及 各国指定的国内频率上统一广播。NAVTEX 接收机是国际公约船舶强制配备的设备之一。

1、国际 NAVTEX 系统使用的专用频率是 518KHz, 采用窄带直接印字电报(NBDP) 的 FEC 方式, 发射类型是 F1B, 向沿海航行的船舶播发海上安全信息。安装NAVTEX接收机的船舶, 自动接收并自主选择打印播发的海上安全信息。NAVTEX系统由陆上MSI提供部门、NAVTEX播发台和船上 NAVTEX 接收机组成。

2、国内 NAVTEX 业务, 指在各国指定的国内频率上(一个中频频率及 4209.5KHz 频率上, 广播和自动接收本国语言的海上安全信息业务)。

FT-7607接收机可在 518KHz(国际频率) 和 490KHz、486KHz/4209.5KHz(国内频率) 上分别接收英文和中文的 NAVTEX 广播信息。

NAVTEX 概念图

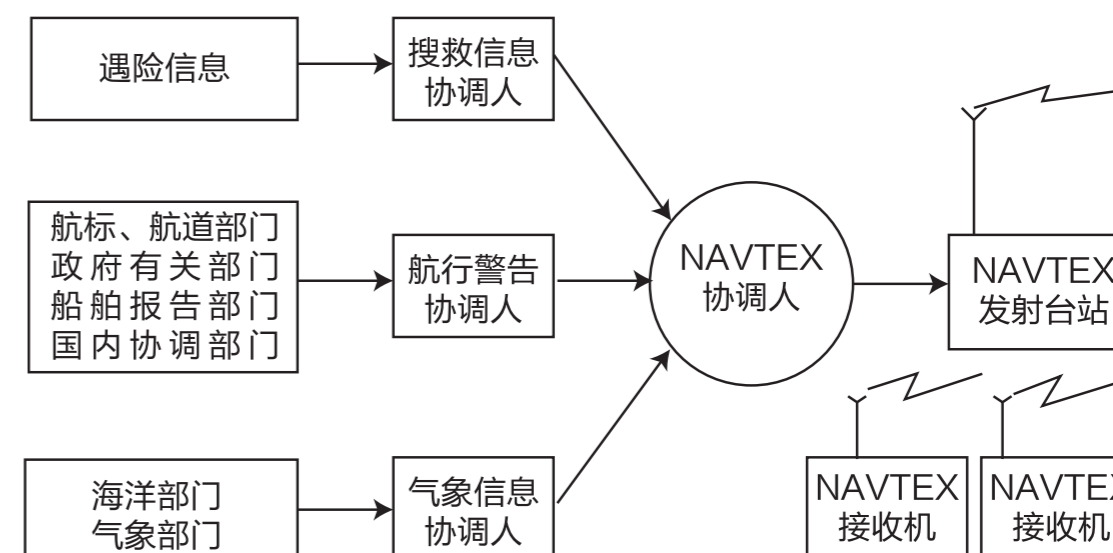

■ NAVTEX原理

IMO将世界划分为16个航行区,每个航区由若干个台站构造一组发信台链,每个航区的岸台台链用无线电传方式播发航行警告、气象预报及紧急信息。为保证这一系统的世界性,一方面规定了统一的广播频率518KHz作为国际NAVTEX频率,发播用英语编写的各类安全信息;另一方面各岸台的发播时间世界范围内统一安排,以保证NAVTEX广播的协调性,广播时间参见[1.4 NAVTEX 发射岸台及广播时间]。

各岸台的发射功率有严格规定,以防止发射台间的相互干扰。一般一个岸台的覆盖范围在250到400海里左右。

通常的NAVTEX接收机可以根据收到信息识别符(B1B2B3B4)来选择信息接收与打印,但有些安全信息,诸如航行警告、气象警告和搜救信息,不能拒绝接收,因为它们对船舶安全航行非常重要。

根据[图1-1NAVTEX概念图],NAVTEX协调机构根据信息内容及各岸台的覆盖范围实施对信息发播岸台的管理和协调,这样可以使NAVTEX接收机仅接收一个或几个岸台的NAVTEX信息。

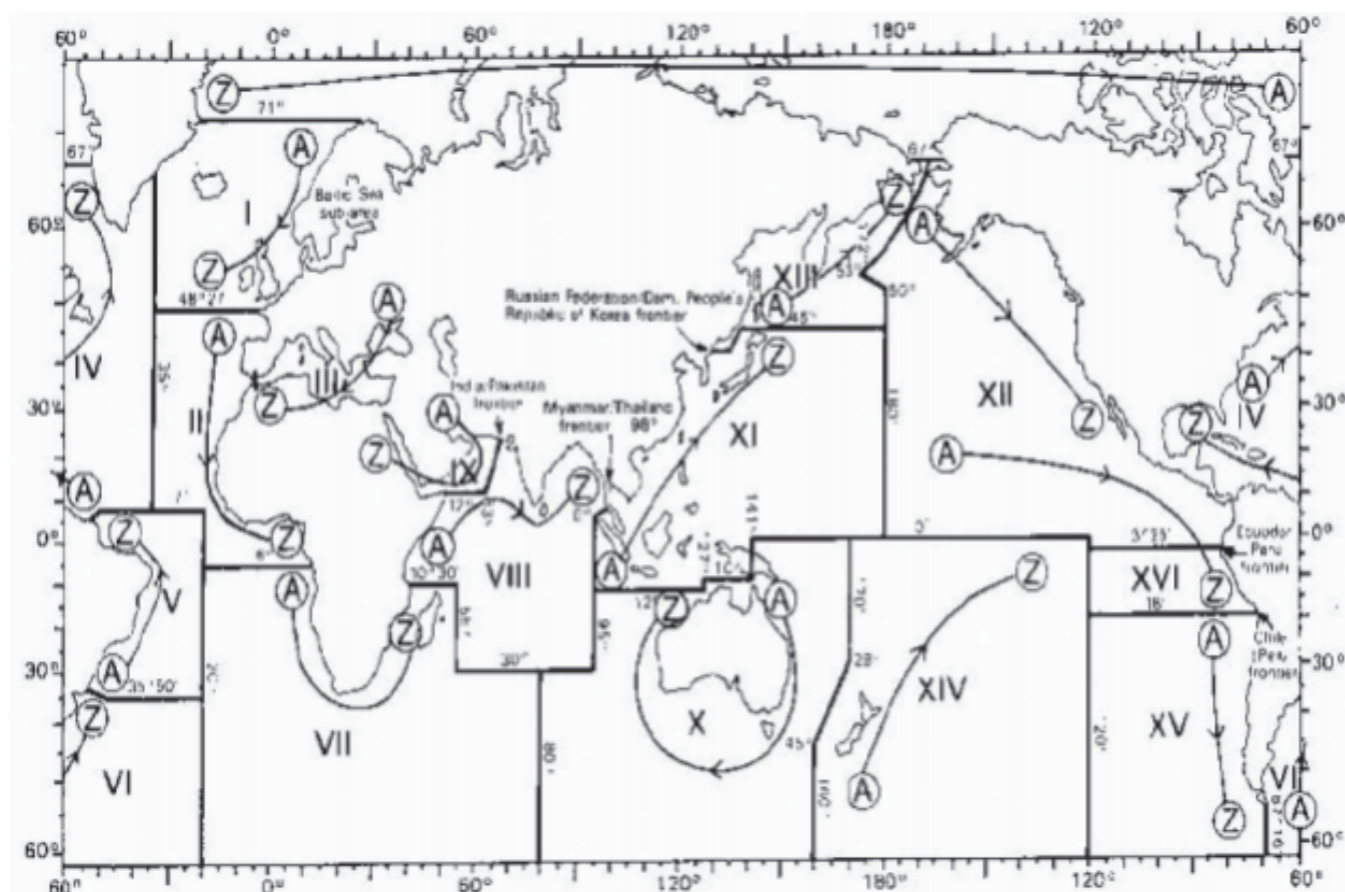

■ NAVTEX信息格式

phasing signal	ZCZC	B1	B2	B3	B4	Message	NNNN
----------------	------	----	----	----	----	---------	------

phasing signal: 定相信号,用于与发射台站同步,时间≥ 10 秒。

ZCZC: 起始符,表示接收信息的开始。

B1(A-Z): 发射台站标识符,用于对发射台的识别,如福州台的标识字母为“0”。

B2(A-Z): 信息类型标识符,具体见 [表 1-1]。

B3、B4(00-99): 信息编号,从 01-99 编排。00 仅为重要信息使用,例如:sAR(搜救)等,只要接收到编号为 00 的任何信息都会无条件的显示或打印,并永久保存于机器中。

Message: 信息电文内容。

NNNN: 结束符,表示接收信息的结尾。

信息类型识别字母

信息类型字母(B2)	说明
A*	Navigational warning 航行警告
B*	Meteorological warning 气象警告
C	Ice Report 冰况报告
D*	search and Rescue Information 搜救信息 piracy and Armed Robbery 海盗劫持报警
E	Meteorological Forecast 气象预告
F	Pilot Message 引水信息
G	AIS Message AIS信息
H	LORAN-C Message 罗兰C 信息
I	Reserved presently not used 保留目前未用
J	SANTNAV Message 卫导信息
K	Other Electronic Navigational Aid system Message 其他助航仪器信息
L*	Navigational warning(additional) 航行警告(附加)
M to Y	Reserved presently not used 保留目前未用
Z	QRU(no message on hand) 手头没有任何信息

※注:带“*”的信息类型,接收机不会拒绝接收。

■ 全球NAVTEX台站信息列表

NAV区域	国家	站台	纬度	经度	频率 (KHz)	范围 (NM)	站台 ID	广播 调度
I	比利时	奥斯坦德	51° 11' N	02° 48' E	518	55	T	0310, 0710, 1110, 1510, 1910, 2310
	爱沙尼亚	塔林	59° 30' N	24° 30' E	518	250	U	0320, 0720, 1120, 1520, 1920, 2320
	冰岛	雷克雅未克电台	64° 05' N	21° 51' W	518	550	R	0250, 0650, 1050, 1450, 1850, 2250
					490	550	R	0318, 0718, 1118, 1518, 1918, 2318
	爱尔兰	瓦伦蒂亚	51° 27' N	09° 49' W	518	400	W	0340, 0740, 1140, 1540, 1940, 2340
		马林黑德	55° 22' N	07° 21' W	518	400	Q	0240, 0640, 1040, 1440, 1840, 2240
	法国	奈顿	50° 35' N	01° 18' W	518	270	K	0140, 0540, 0940, 1340, 1740, 2140
	荷兰	登海尔德	52° 06' N	04° 15' E	518	110	P	0230, 0630, 1030, 1430, 1830, 2230
	挪威	博多电台	67° 16' N	14° 23' E	518	450	B	0010, 0410, 0810, 1210, 1610, 2010
		罗加兰郡	58° 48' N	05° 34' E	518	450	L	0150, 0550, 0950, 1350, 1750, 2150
		瓦尔多电台	70° 22' N	31° 06' E	518	450	V	0330, 0730, 1130, 1530, 1930, 2330
		斯瓦尔巴群岛	78° 04' N	13° 38' E	518	450	A	0000, 0400, 0800, 1200, 1600, 2000
		Orlandet	63° 40' N	09° 33' E	518	450	N	0210, 0610, 1010, 1410, 1810, 2210
	瑞典	比勒克勒布	64° 28' N	21° 36' E	518	300	H	0110, 0510, 0910, 1310, 1710, 2110
		Gislovshammar	55° 29' N	14° 19' E	518	300	J	0130, 0530, 0930, 1330, 1730, 2130
		瓦尔贝里	57° 06' N	12° 23' E	518	300	D	0030, 0430, 0830, 1230, 1630, 2030
	英国	郡卡伦考兹	55° 02' N	01° 26' W	518	270	G	0100, 0500, 0900, 1300, 1700, 2100
					490	270	U	0320, 0720, 1120, 1520, 1920, 2320
		波特帕特里克	54° 51' N	05° 07' W	518	270	O	0220, 0620, 1020, 1420, 1820, 2220
					490	270	C	0020, 0420, 0820, 1220, 1620, 2020
奈顿		50° 35' N	01° 18' W	518	270	E	0040, 0440, 0840, 1240, 1640, 2040	
				490	270	I	0120, 0520, 0920, 1320, 1720, 2120	
奥斯坦德	51° 11' N	02° 48' E	518	150	M	0200, 0600, 1000, 1400, 1800, 2200		
II	法国	Cross Corsen	48° 28' N	05° 03' W	518	300	A	0000, 0400, 0800, 1200, 1600, 2000
					490	300	E	0040, 0440, 0840, 1240, 1640, 2040
	奈顿	50° 35' N	01° 18' W	490	270	T	0310, 0710, 1110, 1510, 1910, 2310	
				518	640	F	0050, 0450, 0850, 1250, 1650, 2050	
	葡萄牙	奥尔塔	38° 32' N	28° 38' W	518	640	F	0050, 0450, 0850, 1250, 1650, 2050
		蒙桑图	38° 44' N	09° 11' W	518	530	R	0250, 0650, 1050, 1450, 1850, 2250
	西班牙	拉科鲁尼亚	43° 21' N	08° 27' W	518	400	D	0030, 0430, 0830, 1230, 1630, 2030
					518	400	G	0100, 0500, 0900, 1300, 1700, 2100
塔里法		36° 01' N	05° 34' W	518	400	G	0100, 0500, 0900, 1300, 1700, 2100	
拉斯帕尔马斯	28° 10' N	15° 25' W	518	400	I	0120, 0520, 0920, 1320, 1720, 2120		
III	保加利亚	瓦尔纳	43° 04' N	27° 46' E	518	350	J	0130, 0530, 0930, 1330, 1730, 2130
	克罗地亚	斯普利特	43° 30' N	16° 29' E	518	85	Q	0240, 0640, 1040, 1440, 1840, 2240
	塞浦路斯	塞浦路斯	35° 03' N	33° 17' E	518	200	M	0200, 0600, 1000, 1400, 1800, 2200
	埃及	亚历山大	31° 12' N	29° 52' E	518	350	N	0210, 0610, 1010, 1410, 1810, 2210
					4209.5	400	X	0750, 1150
	法国	土伦	43° 06' N	05° 59' E	518	250	W	0340, 0740, 1340, 1540, 1940, 2340
					490	250	S	0300, 0700, 1100, 1500, 1900, 2300
	希腊	伊拉克利翁	35° 20' N	25° 07' E	518	280	H	0110, 0510, 0910, 1310, 1710, 2110
		克基拉岛	39° 37' N	19° 55' E	518	280	K	0140, 0540, 0940, 1340, 1740, 2140
		利姆诺斯岛	39° 52' N	25° 04' E	518	280	L	0150, 0550, 0950, 1350, 1750, 2150
	以色列	海法	32° 49' N	35° 00' E	518	200	P	0020, 0420, 0820, 1220, 1620, 2020
	意大利	罗马	41° 48' N	12° 31' E	518	320	R	0250, 0650, 1050, 1450, 1850, 2250

NAV区域	国家	站台	纬度	经度	频率 (KHz)	范围 (NM)	站台 ID	广播 调度
III	意大利	奥古斯塔	37° 14' N	15° 14' E	518	320	V	0330, 0730, 1130, 1530, 1930, 2330
		卡利亚里	39° 14' N	09° 14' E	518	320	T	0310, 0710, 1110, 1510, 1910, 2310
		的里雅斯特	45° 41' N	13° 46' E	518	320	U	0320, 0720, 1120, 1520, 1920, 2320
	马尔他	马尔他	35° 49' N	14° 32' E	518	400	O	0220, 0620, 1020, 1420, 1820, 2220
	俄罗斯联邦	诺沃西比尔斯克	44° 42' N	37° 44' E	518	300	A	0300, 0700, 1100, 1500, 1900, 2300
	西班牙	Cabo de la Nao	38° 43' N	00° 09' E	518	300	X	0350, 0750, 1150, 1550, 1950, 2350
	土耳其	伊斯坦布尔	41° 04' N	28° 57' E	518	300	D	0030, 0430, 0830, 1230, 1630, 2030
		萨姆松	41° 17' N	36° 20' E	518	300	E	0040, 0440, 0840, 1240, 1640, 2040
		安塔利亚	36° 53' N	30° 42' E	518	300	F	0050, 0450, 0850, 1250, 1650, 2050
		伊兹密尔	38° 22' N	26° 36' E	518	300	I	0120, 0520, 0920, 1320, 1720, 2120
乌克兰	马里乌波尔	47° 06' N	37° 33' E	518	280	B	0100, 0500, 0900, 1300, 1700, 2100	
	敖德萨	46° 29' N	30° 44' E	518	280	C	0230, 0630, 1030, 1430, 1830, 2230	
IV	百慕大	百慕大	32° 23' N	64° 41' W	518	280	B	0010, 0410, 0810, 1210, 1610, 2010
	里维埃金纳德	50° 11' N	66° 07' W	518	300	C	0020, 0420, 0820, 1220, 1620, 2020	
						D	0035, 0435, 0835, 1235, 1635, 2035	
						H	0110, 0510, 0910, 1310, 1710, 2110	
						O	0220, 0620, 1020, 1420, 1820, 2220	
						P	0230, 0630, 1030, 1430, 1830, 2230	
						Q	0240, 0640, 1040, 1440, 1840, 2240	
	加拿大	46° 10' N	60° 00' W	518	300	J	0255, 0655, 1055, 1455, 1855, 2255	
						U	0320, 0720, 1120, 1520, 1920, 2320	
						V	0335, 0735, 1135, 1535, 1935, 2335	
						X	0350, 0750, 1150, 1550, 1950, 2350	
						T	0310, 0710, 1110, 1510, 1910, 2310	
						S	0300, 0700, 1100, 1500, 1900, 2300	
	美国	迈阿密	25° 37' N	80° 23' W	518	240	A	0000, 0400, 0800, 1200, 1600, 2000
							F	0445, 0845, 1245, 1645, 2045, 0045
							G	0300, 0700, 1100, 1500, 1900, 2300
							N	0130, 0530, 0930, 1330, 1730, 2130
							R	0200, 0600, 1000, 1400, 1800, 2200
E							0040, 0440, 0840, 1240, 1640, 2040	
库腊索岛	12° 10' N	68° 52' W	518	400	H	0110, 0510, 0910, 1310, 1710, 2110		
					I	0120, 0520, 0920, 1320, 1720, 2120		
VI	阿根廷	Ushaia	54° 48' S	68° 18' W	518	280	M	0200, 0600, 1000, 1400, 1800, 2200
		里约加耶哥斯	51° 37' S	65° 03' W	518	280	N	0210, 0610, 1010, 1410, 1810, 2210
		里瓦达维亚	45° 51' S	67° 25' W	518	280	O	0220, 0620, 1020, 1420, 1820, 2220
		布兰卡	38° 43' S	62° 06' W	518	280	P	0230, 0630, 1030, 1430, 1830, 2230
		马德普拉塔	38° 03' S	57° 32' W	518	280	Q	0240, 0640, 1040, 1440, 1840, 2240
		布宜诺斯艾利斯	34° 36' S	58° 22' W	518	560	R	0250, 0650, 1050, 1450, 1850, 2250
乌拉圭	拉帕洛马	34° 40' S	54° 09' W	518	280	F	0050, 0450, 0850, 1250, 1650, 2050	
				490	280	A	0000, 0400, 0800, 1200, 1600, 2000	
VII	南非	鲸湾港	23° 03' S	14° 37' E	518	378	B	0010, 0410, 0810, 1210, 1610, 2010
		开普敦	33° 40' S	18° 43' E	518	500	C	0020, 0420, 0820, 1220, 1620, 2020
		伊丽莎白港	34° 02' S	34° 02' S	518	500	I	0120, 0520, 0920, 1320, 1720, 2120
VIII	印度	孟买	19° 05' N	72° 50' E	518	250	G	0100, 0500, 0900, 1300, 1700, 2100
		马德拉斯	13° 08' N	80° 10' E	518	400	P	0230, 0630, 1030, 1430, 1830, 2230

NAV 区域	国家	站台	纬度	经度	频率 (KHz)	范围 (NM)	站台 ID	广播 调度	
VIII	毛里求斯	毛里求斯站台	20° 10' S	57° 28' E	518	400	C	0020, 0420, 0820, 1220, 1620, 2020	
IX	巴林	哈马拉	26° 09' N	50° 28' E	518	300	B	0010, 0410, 0810, 1210, 1610, 2010	
	埃及	塞拉比尤姆	30° 28' N	32° 22' E	518	200	X	0350, 0750, 1150, 1550, 1950, 2350	
		库赛尔	26° 06' N	34° 17' E	4209.5	200	X	0750, 1150	
	伊朗	布什尔	28° 59' N	50° 50' E	518	400	V	0330, 0730, 1130, 1530, 1930, 2330	
		阿巴斯港	27° 07' N	56° 04' E	518	300	A	0000, 0400, 0800, 1200, 1600, 2000	
	沙特阿拉伯	吉达	21° 23' N	39° 10' E	518	300	F	0050, 0450, 0850, 1250, 1650, 2050	
	阿曼	马斯喀特	23° 36' N	58° 30' E	518	390	H	0705, 1305, 1905	
	巴基斯坦	卡拉奇	23° 36' N	58° 30' E	518	270	M	0200, 0600, 1000, 1400, 1800, 2200	
	XI	中国	三亚	18° 14' N	109° 30' E	518	400	P	0230, 0630, 1030, 1430, 1830, 2230
			广州	23° 08' N	113° 32' E	518	250	M	0200, 0600, 1000, 1400, 2200
福州			26° 01' N	119° 18' E	518	250	N	0210, 0610, 1010, 1410, 2210	
上海			31° 08' N	121° 33' E	518	250	O	0220, 0620, 1020, 1420, 2220	
大连			38° 52' N	121° 31' E	518	250	Q	0240, 0640, 1040, 1440, 2240	
印尼		查亚普拉	02° 31' S	140° 43' E	518	250	R	0250, 0650, 1050, 1450, 2250	
		安汶岛	02° 31' S	140° 43' E	518	300	A	0000, 0400, 0800, 1200, 1600, 2000	
		孟加锡	03° 42' S	128° 12' E	518	300	B	0010, 0410, 0810, 1210, 1610, 2010	
		雅加达	05° 06' S	119° 26' E	518	300	D	0030, 0430, 0830, 1230, 1830, 2030	
日本		小樽	06° 06' S	106° 54' E	518	300	E	0040, 0440, 0840, 1240, 1640, 2040	
		钏路	43° 19' N	140° 27' E	518	400	J	0130, 0530, 0930, 1330, 1730, 2130	
		横滨	42° 57' N	144° 36' E	518	400	K	0140, 0540, 0940, 1340, 1740, 2140	
		门司	35° 14' N	139° 55' E	518	400	I	0120, 0520, 0920, 1320, 1720, 2120	
		那霸	34° 01' N	130° 56' E	518	400	H	0110, 0510, 0910, 1310, 1710, 2110	
朝鲜共和国		Chukpyong		37° 03' N	129° 26' E	518	400	G	0100, 0500, 0900, 1300, 1700, 2100
						518	200	V	0330, 0730, 1130, 1530, 1930, 2330
		平壤		35° 36' N	126° 29' E	490	200	J	0130, 0530, 0930, 1330, 1730, 2130
						518	200	W	0340, 0740, 1340, 1540, 1940, 2340
马来西亚		檳榔嶼	05° 26' N	100° 24' E	518	200	K	0140, 0540, 0940, 1340, 1740, 2140	
		米里	05° 26' N	100° 24' E	518	350	U	0320, 0720, 1120, 1520, 1920, 2320	
		山打根	04° 28' N	114° 01' E	518	350	T	0310, 0710, 1110, 1510, 1910, 2310	
新加坡		新加坡	05° 54' N	118° 00' E	518	350	S	0300, 0700, 1100, 1500, 1900, 2300	
泰国		曼谷	01° 25' N	103° 52' E	518	400	C	0020-0030, 0420-0430, 0820-0830, 1220-1230, 1620-1630, 2020-2030	
美国		关岛	13° 43' N	100° 34' E	518	200	F	0050, 0450, 0850, 1250	
越南		胡志明市	13° 29' N	144° 50' E	518	100	V	0100, 0500, 0900, 1300, 1700, 2100	
		海防		10° 47' N	106° 40' E	518	400	X	0350, 0750, 1150, 1550, 1950, 2350
						490	400	W	0340, 1540
		岘港	20° 44' N	106° 44' E	4209.5	400	W	0230, 0630, 1030, 1430, 1830, 2230	
台湾	高雄	16° 05' N	108° 13' E	518	400	K	0140, 0540, 0940, 1340, 1740, 2140		
国际海事	香港	22° 29' N	120° 25' E	518	216	P	0230, 0630, 1030, 1430, 1830, 2230		
XII	加拿大	鲁伯特港	22° 13' N	114° 15' E	518	400	L	0150, 0550, 0950, 1350, 1750, 2150	
		托菲诺	54° 20' N	130° 20' W	518	300	D	0030, 0430, 0830, 1230, 1630, 2030	
	美国	旧金山	48° 55' N	125° 35' W	518	300	H	0110, 0510, 0910, 1310, 1710, 2110	
		科迪亚克	37° 55' N	122° 44' W	518	350	C	0400, 0800, 1200, 1600, 2000, 2400	
			57° 46' N	152° 34' W	518	200	J	0300, 0700, 1100, 1500, 1900, 2300	

NAV 区域	国家	站台	纬度	经度	频率 (KHz)	范围 (NM)	站台 ID	广播 调度
XII	美国	火奴鲁鲁	21° 22' N	158° 09' W	518	350	O	0040, 0440, 0840, 1240, 1640, 2040
		威尔士	35° 31' N	121° 03' W	518	350	Q	0445, 0845, 1245, 1645, 2045, 0045
		阿斯托里亚	46° 10' N	123° 49' W	518	216	W	0130, 0530, 0930, 1330, 1730, 2130
XIII	俄罗斯共和国	霍尔姆斯克	47° 02' N	142° 03' E	518	300	B	0010, 0410, 0810, 1210, 1610, 2010
		摩尔曼斯克	68° 46' N	32° 58' E	518	300	C	0020, 0420, 0820, 1220, 1620, 2020
		阿尔汉格尔斯克	64° 51' N	40° 17' E	518	300	F	0050, 0450, 0850, 1250, 1650, 2050
		阿斯特拉罕	45° 47' N	47° 33' E	518	250	W	0340, 0740, 1140, 1540, 1940, 2340
XV	智利	安托法加斯塔	23° 40' S	70° 25' W	518	300	A	0400, 1200, 2000
							H	0000, 0800, 1600
		瓦尔帕莱索	32° 48' S	71° 29' W	518	300	B	0410, 1210, 2010
							I	0010, 0810, 1610
		塔尔卡瓦诺	36° 42' S	73° 06' W	518	300	C	0420, 1220, 2020
							J	0020, 0820, 1620
		蒙特港	41° 30' S	72° 58' W	518	300	D	0430, 1230, 2030
							K	0030, 0830, 1630
		彭塔阿雷纳斯	53° 09' S	70° 58' W	518	300	E	0440, 1240, 2040
							L	0040, 0840, 1640
复活节岛	27° 09' S	109° 25' W	518	300	F	0450, 1250, 2050		
					G	0050, 0850, 1650		
XVI	秘鲁	派塔	05° 05' S	81° 07' W	518	200	S	0300, 0700, 1100, 1500, 1900, 2300
		卡亚俄	12° 03' S	77° 09' W	518	200	U	0320, 0720, 1120, 1520, 1920, 2320
		莫延多	17° 01' S	72° 01' W	518	200	W	0340, 0740, 1140, 1540, 1940, 2340

中国国内NATEX(486KHz)中文业务台站广播时间表

岸台识别码	NAVTEX岸台	广播时间 (UTC)	广播时间 (北京时间)
M	三亚	00:00, 04:00, 08:00, 12:00, 16:00, 20:00,	00:00, 04:00, 08:00, 12:00, 16:00, 20:00,
N	广州	00:10, 04:10, 08:10, 12:10, 16:10, 20:10	00:10, 04:10, 08:10, 12:10, 16:10, 20:10
O	福州	00:20, 04:20, 08:20, 12:20, 16:20, 20:20	00:20, 04:20, 08:20, 12:20, 16:20, 20:20
Q	上海	00:40, 04:40, 08:40, 12:40, 16:40, 20:40	00:40, 04:40, 08:40, 12:40, 16:40, 20:40
R	大连	00:50, 04:50, 08:20, 12:20, 16:20, 20:20	00:50, 04:50, 08:20, 12:20, 16:20, 20:20
T	天津	00:30, 04:30, 08:30, 12:30, 16:30, 20:30,	00:30, 04:30, 08:30, 12:30, 16:30, 20:30,
Z	湛江	00:30, 04:30, 08:30, 12:30, 16:30, 20:30,	00:30, 04:30, 08:30, 12:30, 16:30, 20:30,

更新与维护

■ 诊断测试

诊断测试功能可以了解机器的工作状况,它包括如下8种:

按 **[菜单]** 键,进入主菜单显示;按**[▶]**键,选择**[诊断测试]**子菜单,显示屏幕如图;按**[▼]**键,进入**[诊断测试]**子菜单;按**[▲]****[▼]**键,选择项目;按 **[F2]** 键,确认进入。

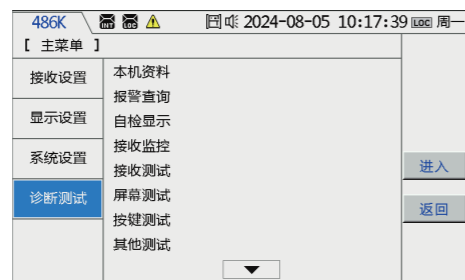

■ 本机资料显示

本机资料图面,可查看本机的基本信息。进入**[诊断测试]**子菜单,按**[▼]**键,选择**[本机资料]**,按 **[F2]** 键,进入本机资料显示图面。

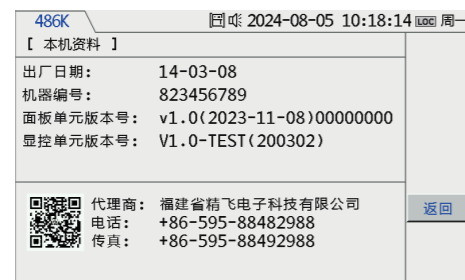

■ 报警信息查询及确认

报警查询图面,可以显示机器的报警时间、状态及报警描述。进入**[诊断测试]**子菜单,按**[▼]**键,选择**[报警查询]**;按 **[F2]** 键,进入报警查询图面。



■ 系统自检显示

机器开机后会进行一系列的自检,可以通过自检显示图面把结果显示出来。进入**[诊断测试]**子菜单,按**[▼]**键,选择**[自检显示]**,按 **[F2]** 键,进入自检显示图面。

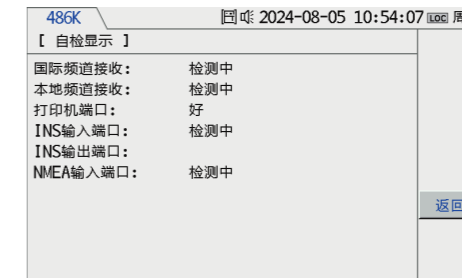

■ 接收信息监控

接收监控图面可以实时显示监控国际频道和本地频道的信息接收字符。进入**[诊断测试]**子菜单,按**[▼]**键,选择**[接收监控]**,按 **[F2]** 键,进入接收监控图面。

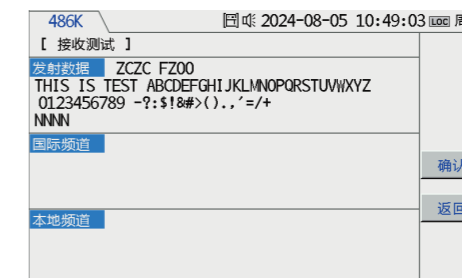

■ 接收信息测试

接收测试主要用于测试本机国际频道和本地频道接收信息是否正常。进入**[诊断测试]**子菜单,按**[▼]**键,选择**[接收测试]**,按 **[F2]** 键,进入接收测试图面,按 **[F2]** 键,屏幕显示“正在发射数据”机器发出Beep音,待测试结束,屏幕显示接收信息及测试判定结果。

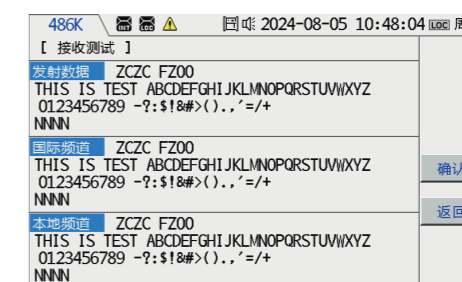

■ 屏幕测试

液晶测试用于对FT-7607显示器的测试。进入[**诊断测试**]子菜单,按[▼]键,选择[**6.屏幕测试**],按[F2]键,进入液晶测试画面,如下图,按[◀][▶]键,选择其他三种显示画面。

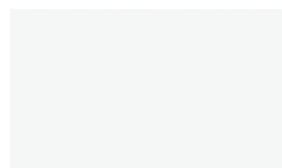

液晶测试画面1



液晶测试画面2



液晶测试画面3



液晶测试画面4

■ 打印机测试

打印机测试主要用于测试打印机是否正常。在正常连接打印机下,进入[**诊断测试**]子菜单,按[▼]键,选择[**打印机测试**]按[F2]键,进入打印机测试画面,如图。按[F2]键,屏幕显示“是/否打印当前信息?”提示,按[◀]键,选择**是**,按[F2]键,确认打印输出,屏幕显示“正在打印测试信息”状态栏图标“”闪动,待打印结束,屏幕显示打印结果:“打印成功”、“打印失败”或“没有连接打印机”。

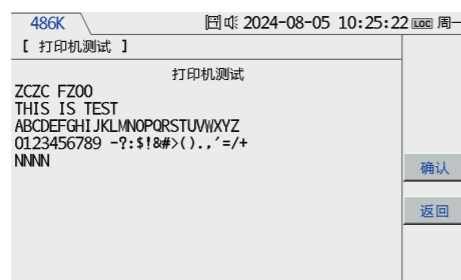

■ 清洗外观

如果机器脏了或布满灰尘,可用软的干布擦拭。
避免使用化学剂或酒精,因为这可能会损坏机器的表面。

■ 置换保险丝

如果保险丝断了或机器停止工作,那么必须查明原因,可能的话换新的保险丝。保险丝装在FUSE盒子内。

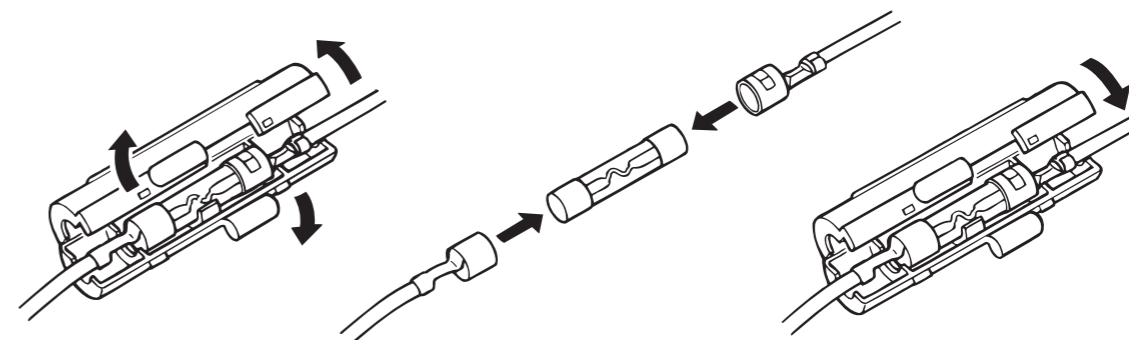

■ 疑难解答

电源	
电源打不开	检查电源接头是否接牢 检查电源正、负极是否接反 检查保险丝是否损坏 检查电源输入是否超过直流+18V 如不能恢复正常工作,请勿自行尝试检查设备内部
接收故障	
不能接收信息	检查距发射台是否超过400海里 检查天线电缆是否短路/开路 检查有没有强信号干扰,如雷达、电台或其他无线电 不能接收(除ABDL外的信息),应检查接收设置