

CNFT[®]

OPERATOR'S MANUAL

操作手册

FT-7900

船载中高频(MF/HF)DSC 无线电装置

Shipborne MF/HF DSC Radiotelephone

福建飞通通讯科技股份有限公司

[FUJIAN FEITONG COMMUNICATION TECHNOLOGY CO., LTD.]

Tel/ +86-595-88481988

Web/ www.cnfeitong.com

Version/ V1.0.1

地址/ 福建省石狮市高新技术开发区电子信息园飞通科技大厦

Addr/ Feitong Technology Building, Electronic Information Park, Hi-Tech
Industrial Development Zone, Shishi City, Fujian Province, China.

福建飞通通讯科技股份有限公司

FUJIAN FEITONG COMMUNICATION TECHNOLOGY CO., LTD.

Safety Instructions

Danger!

- Do not touch the coaxial cable of the antenna coupler during transmission.
- Touching the cable during transmission may result in electric shock, serious injury, or death.
- Do not touch the antenna.
- Touching the antenna during transmission may result in electric shock, serious injury, or death.

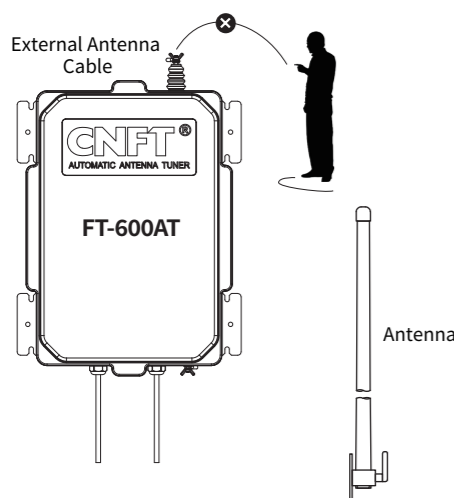

Warning!

- Do not work inside the equipment unless you are fully familiar with electrical circuits.
- Hazardous voltages inside the equipment may cause electric shock.



- Turn off the power at the main distribution panel before starting installation.
- Post a warning near the switch indicating that power must remain off during installation.
- Failure to disconnect power during installation may result in fire, electric shock, or serious injury.

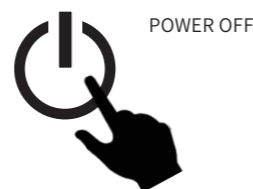

Caution!

- Ensure the power supply voltage matches the rated voltage of the equipment.
- Incorrect power connection may cause fire or equipment damage.
- The rated voltage is indicated on the label at the back of the display unit.
- Handle the grounding copper strap carefully; its edges may cause injury.
- Maintain a minimum compass safe distance of 70 mm.
- Grounding: Ungrounded equipment may emit or receive electromagnetic interference, or cause electric shock.



Contents

Safety Tips.....	01	Distress Operations.....	18-22
Preface.....	04-05	■ Distress Alert Calling Procedure	18
Main Technical Specifications.....	04	◆ Sending Distress Alert	18
Installation Instructions	06-11	◆ Receiving a Distress Alert Acknowledgment Call	19
■ Electrical Installation.....	06	◆ Receiving a Distress Alert Call	19
■ Fixed Installation.....	07	■ Distress Alert Relay Call	20
■ Antenna Tuner Installation.....	10	◆ Relaying a Distress Alert to a Geographical Area	20
■ Antenna Installation.....	11	◆ Receiving a Geographical Area Call Distress Alert	20
Panel Description	12-15	◆ Relaying a Distress Alert to an Individual Vessel	21
■ Display Interface.....	12	◆ Receiving a Distress Alert Relay Acknow- ledgment Call to an Individual Vessel.....	22
■ Front Panel Layout.....	13	◆ Receiving a Distress Alert Relay Call to an Individual Vessel	22
Basic Operations.....	16-17	Routine Call Operation.....	23-34
■ Power On/Off	16	■ Individual Call	23
■ Switch Channels	16	◆ Sending an Individual Call	23
■ User Channel Setup.....	16	◆ Receiving an Individual Acknowledgment Call	23
■ Tune ATU.....	16	◆ Receiving an Individual Call	24
■ Transmission Modes.....	16	■ Geographical Area Call	24
■ DSC Test Call.....	16	◆ Sending a Geographical Area Call	24
■ Alarm.....	16	◆ Receiving a Geographical Area Call	25
■ Squelch.....	16	■ Group Call	26
■ Attenuation.....	17	◆ Sending a Group Call.....	26
■ Noise Block.....	17		
■ Set Transmit Power.....	17		
■ Scanning.....	17		
■ Backlight.....	17		
■ Mark a Channel.....	17		
■ DSC Routine Channel Scanning.....	17		

◆ Receiving a Group Call27	◆ Audio Settings40
■ PSTN Call27	◆ Antenna Tuning Settings40
◆ Sending a PSTN Call27	◆ Power Settings (Available in Korea Region Only)41
◆ Receiving a PSTN Acknowledgment Call28	◆ Baud Rate Settings41
◆ Receiving a PSTN Call29	◆ Display Mode Settings42
■ Position Request Call29	■ Digital Selective Calling (DSC) Settings42
◆ Sending a Position Request Call.....29	◆ Local MMSI Settings42
◆ Receiving a Position Acknowledge Call30	◆ Position Settings43
◆ Receiving a Position Request Call.....30	◆ Acknowledge Settings43
■ Test Call31	◆ Print Settings44
◆ Sending a Test Call31	◆ Frequency Conversion Settings44
◆ Receiving a Test Acknowledge Call31	◆ Special Call Settings45
◆ Receiving a Test Call32	■ Memory Reset45
■ Neutral Craft Call33	■ Self-Test45
■ Medical Transport Call33	■ Service Information45
■ Polling Call34	■ GNSS Connection46
Menu Operation.....35-45	■ Interface Specification47-54
■ Use the Menu35	■ Appendix: Frequency Tables55-61
■ Address List35	■ Maintenance62
■ Call File36	■ 操作手册中文版64(起)
■ Call Log37	
■ System Setup37	
◆ Local Time Settings37	
◆ Time Offset Settings38	
◆ Timeout Settings38	
◆ Speaker Settings39	
◆ Language Settings39	

Preface

Thank you for choosing our Model: FT-7900, Name: MF/HF Radiotelephone with Class A DSC. The product includes the main unit as well as accessories listed in the Packing List. Before installing or using the product, please read the User Manual carefully to avoid equipment damage or personal safety risks due to improper or unprofessional operation. Our company does not assume any responsibility for consequences arising from such incidents.

※**Note: If the product is upgraded or updated, resulting in discrepancies between this manual and actual operation, please refer to the device itself as the final reference.**

Main Technical Specifications

The device is powered by a 12V DC supply with an output current of no less than 45A.

(1) Temperature Range: -15°C to +55°C

(2) Relative Humidity: 0~95%

ITEM	Technical Parameters		
Overall Specifications	Frequency Range	Transmitter Frequency 1.6MHz~27.5MHz; Receiver Frequency 0.5MHz~29.9999MHz	
	Output Power	≤150W	
	Frequency Deviation	±10Hz(1605kHz~27500kHz)	
	Channel Capacity	≥400	
	Operating Mode	Wireless Telephony: J3E (USB, LSB), H3E (AM); DSC: F1B (FSK)	
	Compass Safe Distance	70cm	
	Display/Dimensions	5-inch full-color LCD / 160(H) × 300(W) × 300(D) mm	
	Interface	RS-232, RS-422	
	Net Weight	7600g	
	Operating Temperature	-15° ~ 55°C	
	Protection Level	Transceiver Unit: IP22; Antenna Tuner: IP66	
	Transmission	Frequency Deviation	≤±10Hz(1605kHz~27500kHz)
		FM Residuals	≤±5Hz
Intermodulation Components		≤-25dB	
Microphone Sensitivity		-9dB ≤ Δ(Signal Variation) ≤ -3dB (1000Hz, 94dBA)	
Residual AC Noise		≤40dB	
Noise Power		≤40dB	
Spurious Frequency Modulation		≥-26dB	
Carrier Suppression		≥40dB	
Conducted Spurious Emissions	9kHz to 2GHz ≤43dB; 2GHz to 4GHz ≤43dB		

ITEM	Technical Parameters	
Transmission	Frequency Deviation	$\leq \pm 10\text{Hz}$
	FM Residuals	$\leq \pm 5\text{Hz}$
	Audio Passband	350Hz~2700Hz
Reception	Maximum Usable Sensitivity	1605kHz-4000kHz: J3ED $\geq +16\text{dBuV}$ 、H3E $\geq +30\text{dBuV}$ F1B(Digital Output) $\geq +5\text{dBuV}$ 、F1B(Analog Output) $\geq +10\text{dBuV}$ 4MHz-27.5MHz: J3E $\geq +11\text{dBuV}$ F1B(Digital Output) $\geq +0\text{dBuV}$ 、F1B(Analog Output) $\geq +5\text{dBuV}$
	Adjacent Channel Selectivity	-1kHz and +4kHz $\geq 40\text{dB}$ -2kHz and +5kHz $\geq 50\text{dB}$ -5kHz and +8kHz $\geq 60\text{dB}$
	Blocking	$\geq +65\text{dB}$
	Intermodulation	$\geq +90\text{dBu}$
	Mutual Modulation	$\geq +80\text{dBuV}$
	Spurious Response Rejection Ratio	$\geq 60\text{dB}$
	Audio Intermodulation	$\leq -25\text{dB}$
	Total Harmonic Distortion Factor	$\leq 5\%$
	Internally Generated Spurious Signals	J3E: $\geq 10\text{dB}$
	Conducted Spurious Radiation	9kHz~2GHz: $\leq 2\text{nW}(-57\text{dBm})$ 、2GHz~4GHz: $\leq 20\text{nW}(-37\text{dBm})$
	AGC-Improved Signal-to-Noise Ratio	J3E: $\geq 15\text{dB}$
	AGC Range	$\leq 10\text{dB}$
	Audio Output Level	$\geq 2\text{W}$
	AGC Time Constant	Startup Time: 5ms-10ms , Recovery Time: 1s-4s
	Cross-Modulation	J3E: $\geq +100\text{dBuV}$
DSC	Frequency Deviation	$\leq \pm 10\text{Hz}$ (1615Hz和1785Hz)
	Call Sensitivity	1 μV , Bit Error Rate $\leq 10^{-2}$
	Nominal Modulation Rate	100bit/s(50Hz)
	Residual Modulation	$\leq -26\text{dB}$
	Adjacent Channel Selectivity	-1kHz and +4kHz $\geq 45\text{dB}$ 、-2kHz and +5kHz $\geq 50\text{dB}$ -5kHz and +8kHz $\geq 60\text{dB}$
	Intermodulation	$\geq +90\text{dBu}$
	Mutual Modulation	$\geq +80\text{dBuV}$
DSC	Spurious Response Rejection Ratio	$\geq 60\text{dB}$
	Audio Intermodulation	$\leq -25\text{dB}$

Installation Instructions

Electrical Installation

Before using the device, ensure proper connection of the power supply, antenna, and necessary external device. The device requires a 12V DC power supply with an output current of no less than 45A.

Connection diagram

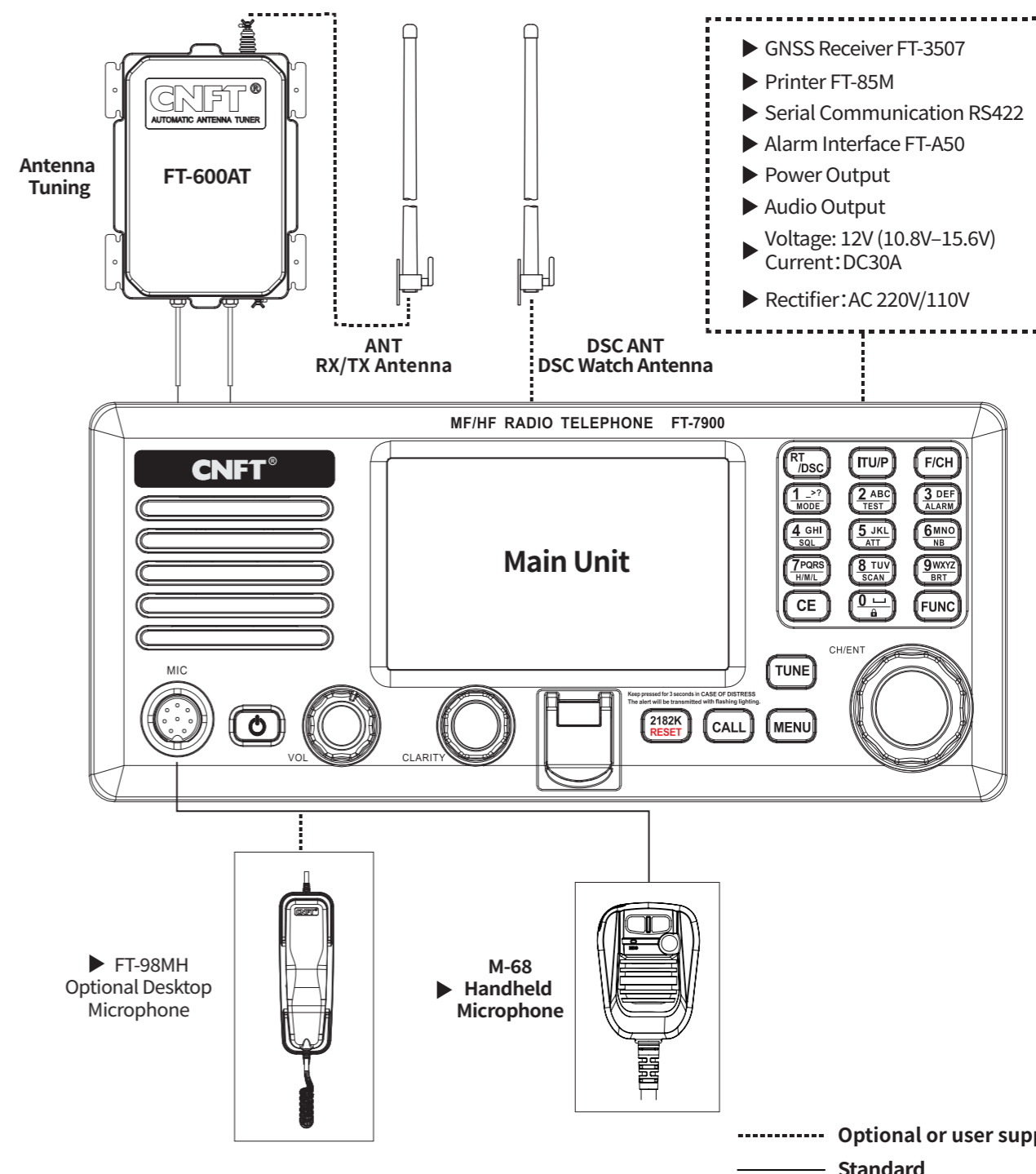

■ Fixed Installation

- ※ The product should be installed in a well-ventilated area, away from the engine.
- ※ Do not install it in direct sunlight.
- ※ Do not place the product within 1 meter of the compass.

- 1: The product is equipped with a reversible mounting bracket, secured with five screws.
- 2: Before installation, ensure a 100mm vertical clearance and 70mm horizontal clearance behind the bracket for product adjustment.
- 3: The tilt angle of the product can be adjusted using the clamp.

Main Unit-Desktop Mounting

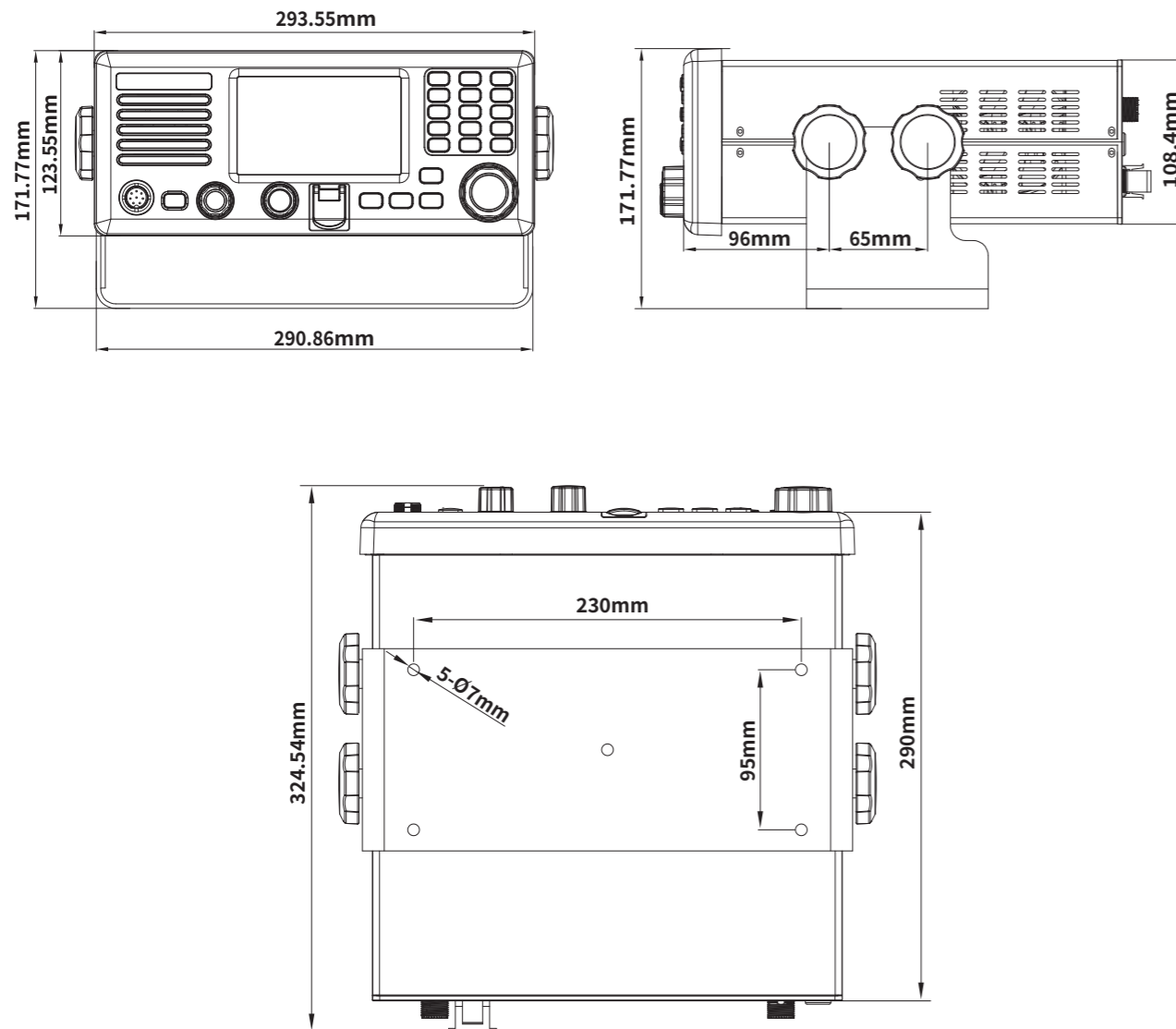

Main Unit-Ceiling Mounting

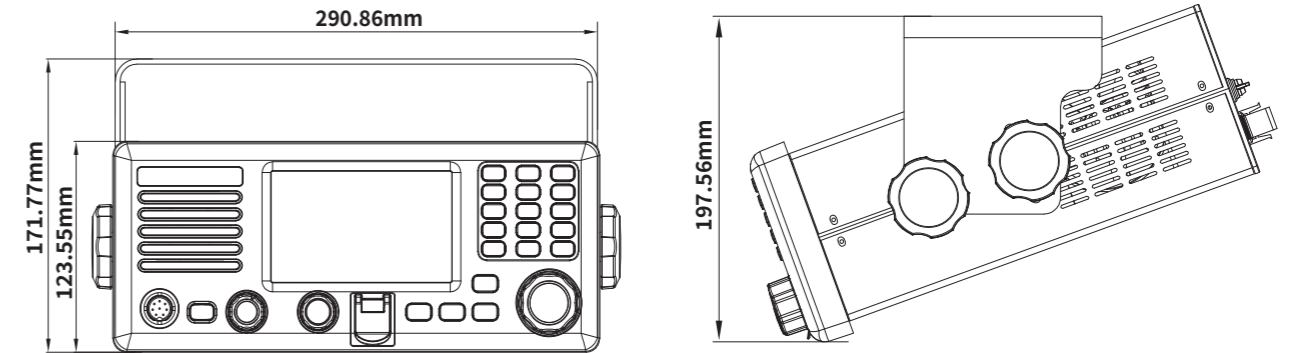

Antenna Tuner Mounting

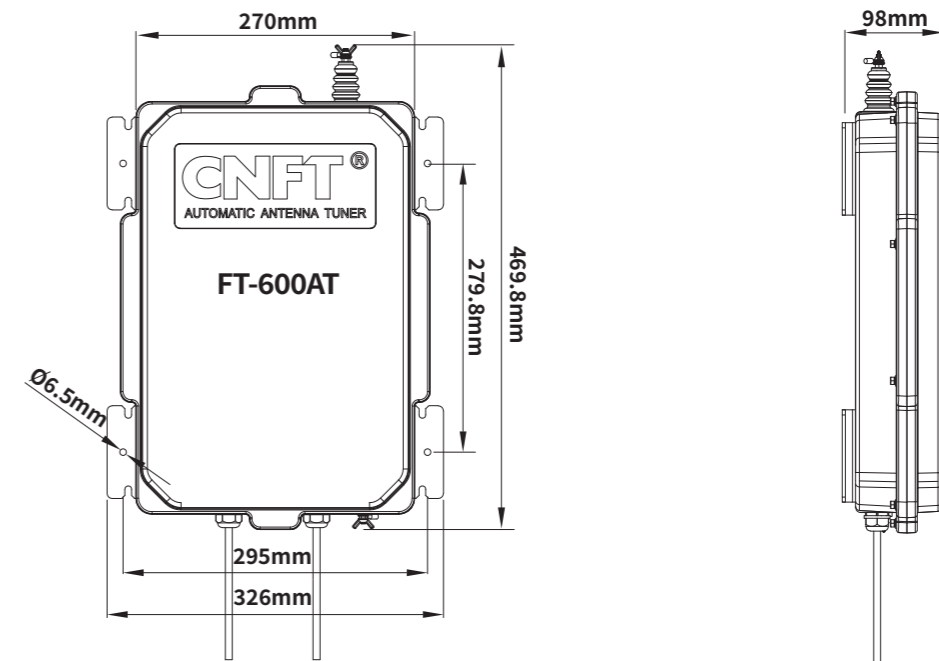

■ Antenna Installation

Antenna Installation Diagram

Proper antenna installation is crucial for minimizing interference and achieving optimal communication range. Please note the following points during installation:

- ① The antenna should be mounted in a vertical position and kept as far as possible from conductive objects on a horizontal plane. The minimum distance should not be less than 0.5 meters. The antenna should not be placed near large vertical objects and must maintain 360° unobstructed clearance.
- ② The antenna should be kept away from high-power transmitters, such as radar, radio stations, or other wireless antennas. Ideally, maintain a minimum distance of 3 meters.
- ③ Two antennas should not be installed on the same side. If they must be on the same side, ensure a minimum spacing of 10 meters. If conditions do not allow, install the antennas vertically, with a height difference of at least 2.5 meters.
- ④ Outdoor cable interfaces must be waterproofed.
- ⑤ Antenna cable length should be kept as short as possible and should be kept away from power cables. If crossing power cables, maintain a 90° perpendicular angle.
- ⑥ If installing on a light pole, use insulating materials for isolation and ensure the height is at least 1.5 meters above ground.

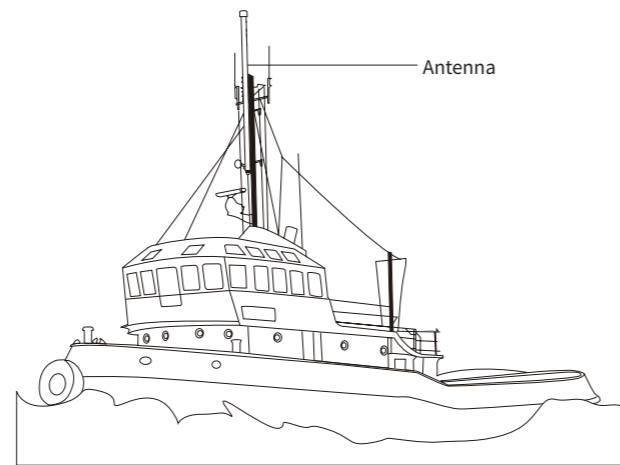

Whip Antenna Installation Diagram

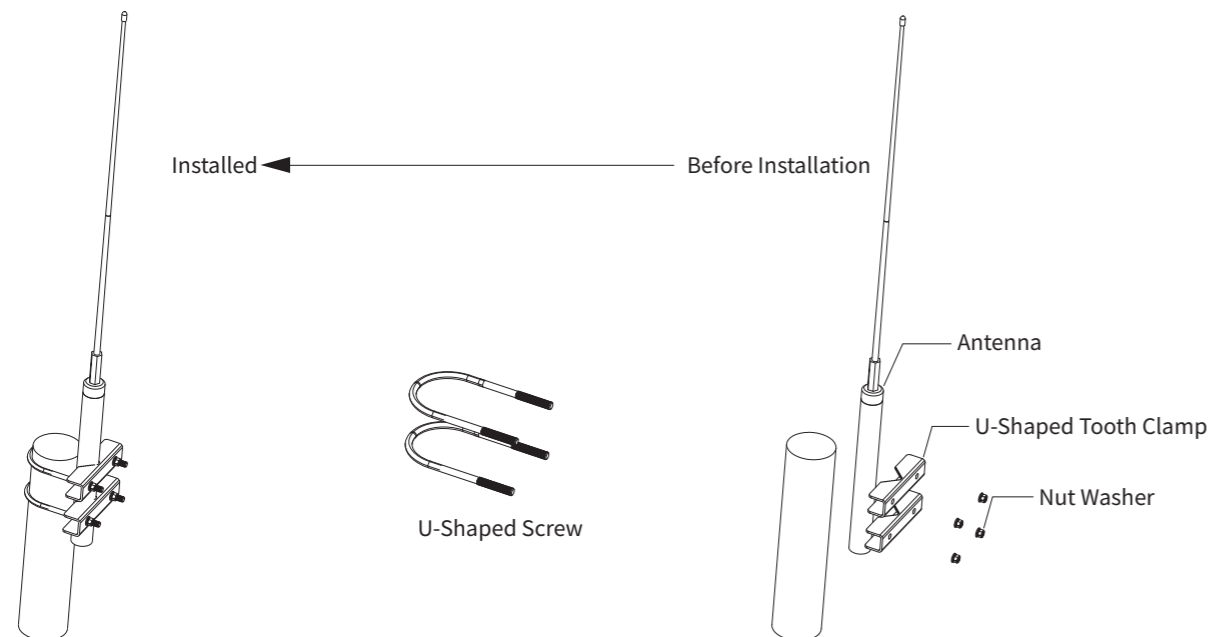

Panel Overview

■ Display Interface

Display Interface Operating Instructions

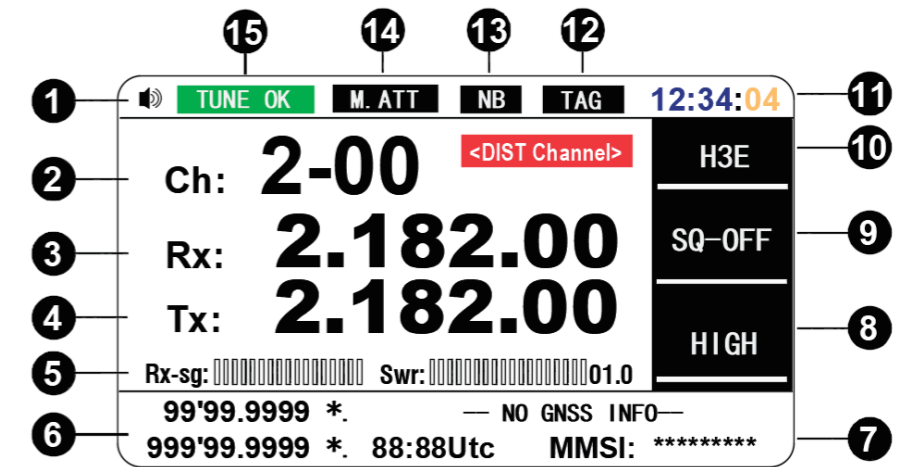

- ① Speaker Status
- ② Channel Attributes & Channel Number
- ③ Receive Frequency
- ④ Transmit Frequency
- ⑤ Receive Signal Strength Indicator & Transmit Signal Power Indicator, Antenna Standing Wave Ratio (SWR) Display
- ⑥ GNSS Information
- ⑦ Local MMSI Number
- ⑧ Power Setting Indicator
- ⑨ Squelch On / Off
- ⑩ Signal Type Indicator
- ⑪ Local Time
- ⑫ Current Channel Marked/Memory (Marked) Indicator
- ⑬ Noise Suppression (Noise Reduction) Function Indicator
- ⑭ Signal Attenuation (High Gain Attenuation or Medium Gain Attenuation) Function Indicator
- ⑮ Antenna Tuner (ATU) Status

■ Front Panel Layout

Key Operation Instructions

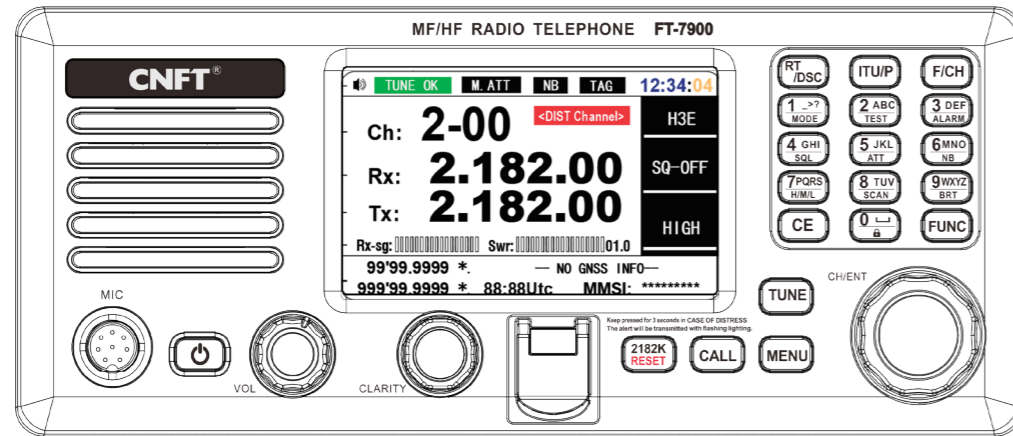

MIC	Microphone Socket
Power	After correctly connecting the device's power, press and hold for 3 seconds to turn on or off.
VOLUME	Adjust the audio output level. Turn the knob clockwise to increase the volume and counterclockwise to decrease it.
CLARITY	Adjust reception frequency by ±10Hz for clearer reception of frequency-shifted signals (knob).
DISTRESS	Open the red protective cover, then press and hold this button for 5 seconds to send a distress call.
2182K	Press to cycle through 2182K -> 4125K -> 6215K -> 8291K -> 12290K -> 16420KHz.
CALL	Open the call list menu to edit calls for sending/saving.
TUNE	Antenna tuning switch, activated only when the device is connected to an ATU unit.
MENU	Open the system main menu.
LOG	Open the DSC call log file.

CH/ENT	Rotate to change cursor position for channel and frequency on the main interface; in other interfaces, adjust the cursor. Press to confirm (knob).
RT/DSC	Switch between DSC scan reception interface and RT main interface.
ITU/P	Select frequency user channel group and ITU maritime channel group.
F/CH	On the main interface, choose the cursor position for editing: CH channel number -> RX frequency -> TX frequency. Use numeric keys to edit the channel number or frequency at the corresponding cursor position.
CE	Cancel the current operation and return to the previous menu.
FUNC	Enable numeric key reuse function. When pressed, the display shows the "FUNC" indicator. Press a numeric key again to activate its reuse function.
1-? MODE	Default Function <1>, Reuse Function <MODE>: Switch signal type: Upper Sideband (USB) -> Lower Sideband (LSB) -> Amplitude Modulation (H3E) -> Narrowband R (RLX)
2 ABC TEST	Default Function <2>, Reuse Function <TEST>: Open DSC test call editing interface (*Only DSC devices can activate this function*)
3 DEF ALARM	Default Function <3>, Reuse Function <ALARM>: At 2182KHz, the device alternates between 2200Hz and 1300Hz emergency audio signals. Use only in distress situations
4 GHI SQL	Default Function <4>, Reuse Function <SQL>: Squelch switch. When enabled, the display shows "SQ-ON" (Squelch On) eliminating unwanted background noise when no signal is received. When disabled, the display shows "SQ-OFF" (Squelch Off) .
5 JKL ATT	Default Function <5>, Reuse Function <ATT>: If the receiver's signal level is too high, causing distortion, enable this function to attenuate the signal at high-frequency or mid-frequency amplification to eliminate distortion. The display will show "H-ATT" or "M-ATT" indicators
6 MNO NB	Default Function <6>, Reuse Function <NB>: Enable noise suppression to remove pulse-type noise, such as transmitter ignition noise. The display will show the "NB" indicator
7 PORS H/M/L	Default Function <7>, Reuse Function <H/M/L>: Switch transmitter output power: High Power(HIGH) -> Medium Power (MID) -> Low Power (LOW)
8 TUV SCAN	Default Function <8>, Reuse Function <SCAN>: Open scan interface, Section 3.12
9 WXYZ BRT	Default Function <9>, Reuse Function <BRT>: Open backlight brightness adjustment dialog, Section 3.13
0 Lock	Default Function <0>, Reuse Function <Keyboard Lock>: Lock button/knob operations. When enabled, the display shows the "Lock" indicator (keyboard lock prompt). Buttons and knobs will not respond. Press this key again to unlock, and the "Lock" indicator disappears. *During keyboard lock, the [2182K] and [DISTRESS] keys remain responsive for emergency operations*
LCD	5-inch TFT Display

Front View

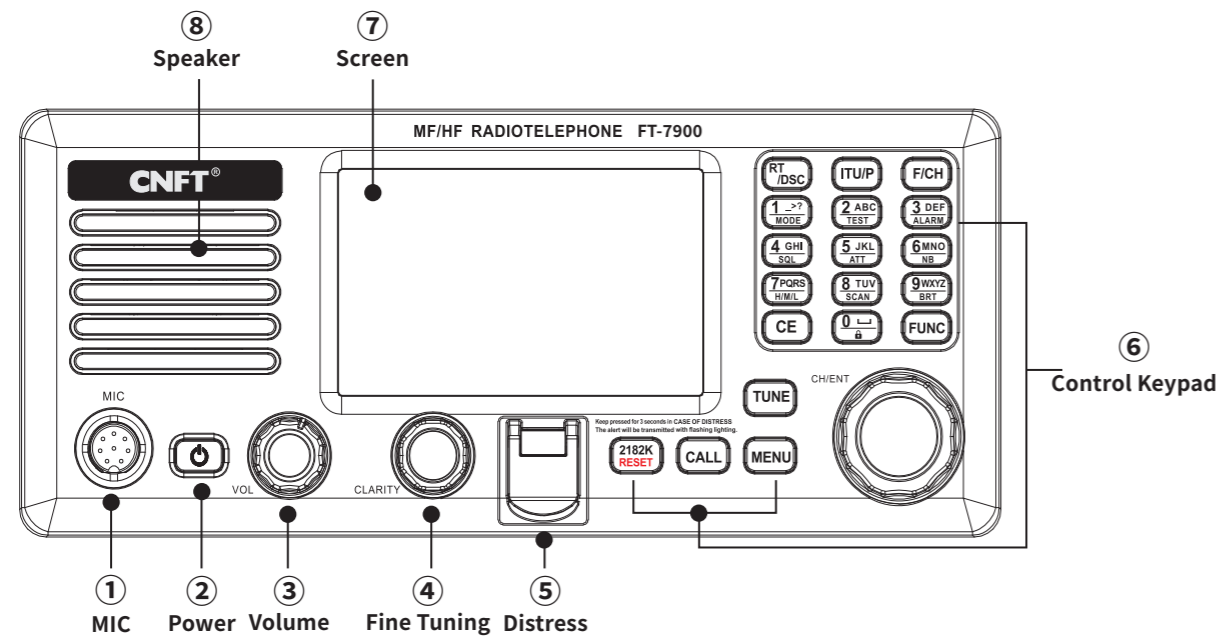

Rear View

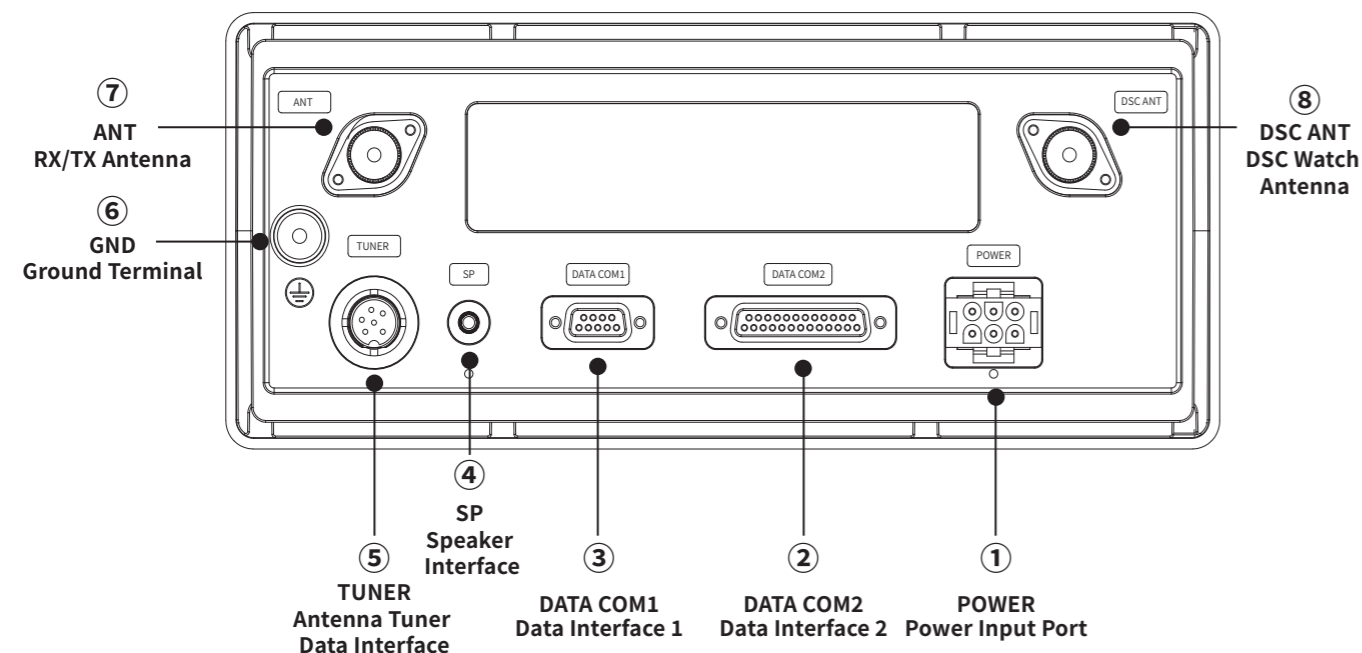

Basic Operations

◆ Power On/Off

After properly connecting the device to the power supply, press and hold the **[Power]** button for 3 seconds to turn it on/off.

◆ Switch Channels

The FT-7900 has two channel modes: User Channel Mode and ITU International Channel Mode. While in standby mode, press the **[ITU/P]** button to switch modes. Then, turn the **[CH/ENT]** knob to change channels or enter the channel number using the **[0]~[9]** buttons and confirm with **[CH/ENT]**. The user-defined channels range from CH1 to CH200.

◆ User Channel Setup

While in User Channel Mode, press the **[F/CH]** button to select the item to edit (including CH channel number, RX receive frequency, TX transmit frequency). Use the **[Numeric]** keys to enter the desired value, then confirm with **[ENT]** or **[F/CH]** button. Press **[CE]** to clear input.

※ In ITU International Channel Mode, frequencies cannot be modified.

◆ Tune ATU

Press the **[TUNE]** button to start tuning the ATU. Once tuning is completed, the main screen will display "TUNE OK".

※ If the Antenna Type is set to Broadband Antenna in the menu, tuning is not required.

◆ Transmission Modes

While in the main interface, press the **[FUNC]** button, and the "FUNC" icon will appear on the right side of the display. Press **[1/Mode]** to switch signal types in the following sequence: Upper Sideband (USB)-> Lower Sideband (LSB)-> Amplitude Modulation (H3E)-> Narrowband R (RLX).

◆ DSC Test Call

While in the main interface, press the **[FUNC]** button, and the "FUNC" icon will appear on the right side of the display. Press **[2/TEST]** to open the call editing interface. Please refer to Section 5.6 of this manual for detailed instructions.

◆ Alarm

To ensure compatibility with older Single Sideband (SSB) transceivers, the FT-7900 is equipped with an alarm function. While in the main interface, press the **[FUNC]** button, and the "FUNC" icon will appear on the right side of the display. Press **[3/ALARM]**, and the device will transmit an alarm signal on 2.182 MHz using H3E signal mode.

The alarm signal consists of frequencies 1300 Hz and 2200 Hz. Press **[CE]** to deactivate the alarm.

◆ Squelch

While in the main interface, press the **[FUNC]** button, and the "FUNC" icon will appear on the right side of the display. Press **[4/Squelch]** to toggle the squelch function on or off.

◆ Attenuation

While in the main interface, press the [FUNC] button, and the "FUNC" icon will appear on the right side of the display. Press [5/ATT] to cycle through RF Attenuation or IF Attenuation, which will be displayed accordingly.

◆ Noise Block

While in the main interface, press the [FUNC] button, and the "FUNC" icon will appear on the right side of the display. Press [6/NB] to enable the ATT function, and the display will show "NB".

◆ Set Transmit Power

On the main interface, press the [FUNC] key. The "FUNC" icon will appear on the right side of the display. Then, press the [7/H/M/L] key to toggle the transmit power.

◆ Scanning

On the main interface, press the [FUNC] key. The "FUNC" icon will appear on the right side of the display. Then, press the [8/SCAN] key to open the scan settings menu.

Rotate the [CH/ENT] knob to select the S-TYPE(scan type) and S-SPEED(scan speed), then select the <START> option. The device will begin scanning.

If squelch is enabled and the channel scan mode is active, the FT-7900 will stop scanning when a valid signal is received. The device will resume scanning 3 seconds after the signal disappears.

◆ Backlight

On the main interface, press the [FUNC] key. The "FUNC" icon will appear on the right side of the display. Then, press the [9/BRT] key to open the backlight adjustment dialog.

Rotate the [CH/ENT] knob to select the desired display backlight level. Rotate the [CLARITY] knob to adjust the keypad backlight level. Press the [CE] key to close the dialog.

◆ Mark a Channel

On the main interface, press the [CH/ENT] key to mark the current channel. The "TAG" icon will appear on the display, indicating the channel is marked for scanning.

If the current channel is already marked, pressing the [CH/ENT] key will remove the mark.

◆ DSC Routine Channel Scanning

Standard calls can utilize the receiver for scanning six frequencies.

a: Press the [RT/DSC] key on the panel to open the scan interface. The receiver will start scanning the DSC routine channels, which can be set to six reception frequencies.

b: Press the [FUNC] key to stop the DSC routine channel scanning. Emergency DSC channels cannot be stopped.

c: Press the [CH/ENT] key to open the frequency list. Use the channel knob to select the frequency to set, then press the [CH/ENT] key to confirm.

d: Press the [FUNC] key to resume scanning. Press the [CE] key to exit.

Distress Operations

※DSC operations must be performed only when the device has a valid MMSI number. If there is no valid MMSI number, pressing the [DISTRESS] key and [CALL] key will trigger a warning message indicating the absence of an MMSI number. The following operations assume that the device has been configured with a valid MMSI number and is properly connected to a GNSS device.

◆ Distress Alert Calling Procedure

◇ Sending Distress Alert

a: First, press the [DISTRESS] key on the panel to open the distress alert call transmission interface, as shown in Figure 4.1.1.

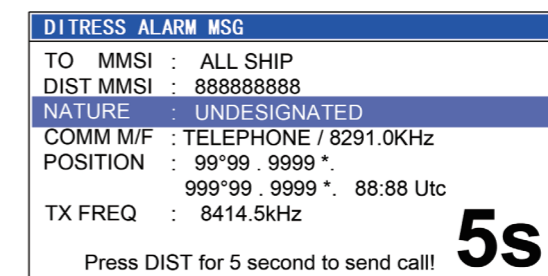

Figure 4.1.1

b: Press the [CH/ENT] key to open the distress category list. Use the channel knob to select the <NATURE> option (distress type). Available distress types include fire, flooding, collision, grounding, listing, sinking, adrift, undesignated, abandoning, piracy, and man overboard—11 types in total. The default selection is "undesignated". Press the [CH/ENT] key to confirm.

c: The device allows manual input of GNSS information. Rotate the channel knob to move the cursor to the <POSITION> option. Use the [NUMERIC] keys to enter GNSS coordinates. Rotate the [CLARITY] knob to adjust the cursor position.

d: Rotate the channel knob to move the cursor to the <TX FREQ> (Transmit Frequency). Press the [CH/ENT] key to open the DSC frequency selection dialog. There are three transmission modes:

1. MULTI FREQ -> Multi-frequency transmission, where the distress call is sent on six frequencies.
2. AUTO FREQ -> Automatic frequency transmission, where the distress call cycles through six frequencies with an interval of 3.5–4.5 minutes.
3. Single frequency transmission, where the distress call is sent on the selected frequency.

e: Press and hold the [DISTRESS] key for 5 seconds. After 5 seconds, the distress alert call will be sent.

Once the distress alert call is transmitted, the device enters a waiting-for-response mode. In this mode, the device switches to the designated distress channel for communication and emits an alarm tone at random intervals between 20–50 seconds. If no response is received within 3.5–4.5 minutes, the device will automatically resend the distress alert call. Selecting <Stop> will disable automatic retransmission, while selecting <Resend> will immediately retransmit the distress alert call.

If a distress alert call is mistakenly sent, the following procedure must be followed to cancel the alert:

a) In the waiting-for-response mode, select <Cancel> to send a distress alert cancellation message and terminate the alert.

b) Use the radio to report your information on the relevant frequency. For example: "All ships... All ships... All ships... This is (Ship Name and Station Call Sign), MMSI XXXXXXXX, my position is XX°XX' N, XXX°XX' E. On XXXX-XX-XX at XX:XX UTC, I am canceling my distress alert of an unspecified type!"

c) Proceed with other operations.

◇ Receiving a Distress Alert Acknowledgment Call

When the device receives a distress alert acknowledgment call, an alarm sound will be emitted, and the distress acknowledgment call information will be displayed. At the same time, the device will automatically switch to the dedicated distress channel for communication. The screen will display the interface shown in Figure 4.1.2.

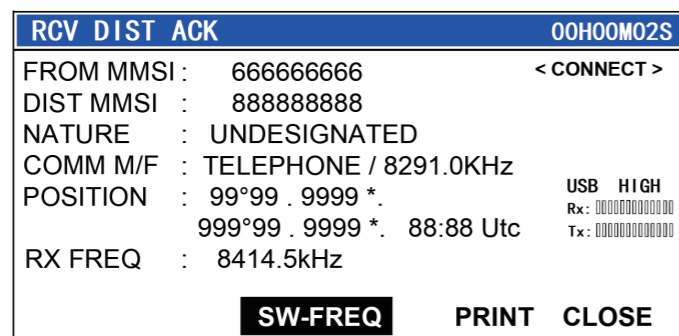

Figure 4.1.2

◇ Receiving a Distress Alert Call

When the device receives a distress alert call, an alarm sound will be emitted, and the distress call information will be displayed. The device will automatically switch to the corresponding dedicated distress channel for communication. The screen will display the interface shown in Figure 4.1.3.

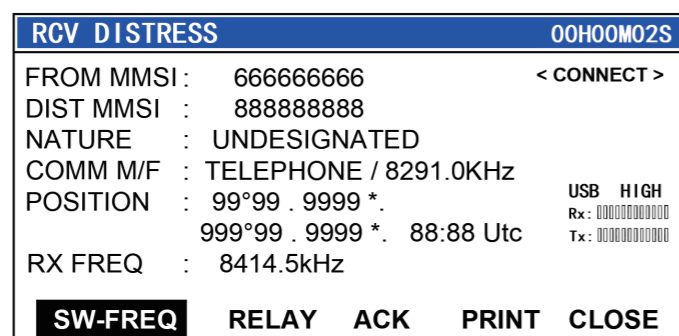

Figure 4.1.3

To switch to another distress channel, select <SW-FREQ>, then press [CH/ENT] to open the distress channel list and choose the appropriate channel.

To forward the distress alert, select <RELAY>, then press [CH/ENT] to open the forwarding type menu. Choose whether to forward to a single station or a maritime area. Enter the target, then press [CH/ENT] to open the DSC frequency selection dialog. Choose the transmission mode, then press [CH/ENT] to send the call.

If you need to send a distress alert acknowledgment call, select <ACK>, then press [CH/ENT] to transmit the acknowledgment call.

Press [CE] or select <Close> to return to the main interface.

◆ Distress Alert Relay Call

◇ Relaying a Distress Alert to a Geographical Area

a: Press the [CALL] key on the panel to open the call type list.

b: Use the channel knob to select <DISTRESS RELAY GEOGRAPHIC MSG>, then press [CH/ENT] to open the editing interface, as shown in Figure 4.2.1.

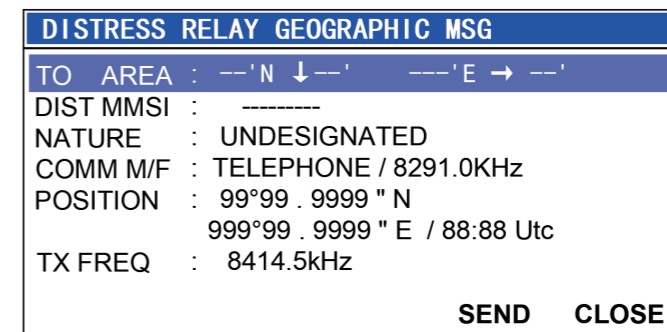

Figure 4.2.1.

c: Rotate the channel knob to select <AREA>. Press [CH/ENT] to open the geographical area type selection dialog. Choose the desired area type, then use the numeric keys to enter the area information. Rotate the [CLARITY] knob to adjust the cursor position.

d: Rotate the channel knob to select <DIST MMSI> (Distressed Vessel) . Use the numeric keypad to enter the MMSI number of the distressed vessel. Alternatively, press [CH/ENT] to open the contacts list and select the MMSI number from the directory.

e: Rotate the channel knob to select <NATURE> (Distress Type) . Distress categories include: Fire, Flooding, Collision, Grounding, Listing, Sinking, Adrift, Undesignated, Abandoning, Piracy, and Man Overboard—11 types in total. The default selection is "UNDESIGNATED" Press [CH/ENT] to confirm.

f: Rotate the channel knob to select <POSITION>. Use the numeric keys to enter the distressed vessel's position coordinates. Rotate the [CLARITY] knob to adjust the cursor position.

g: Rotate the channel knob to move the cursor to <TX FREEQ> Transmit Frequency. Press [CH/ENT] to open the DSC frequency selection dialog. There are three transmission modes:

1. MULTI FREQ-> Multi-frequency transmission, where the distress call is sent on six frequencies.
2. AUTO FREQ-> Automatic frequency transmission, where the distress call cycles through six frequencies with an interval of 3.5–4.5 minutes.
3. Single frequency transmission, where the distress call is sent on the selected frequency.

After selecting the mode, press [CH/ENT] to confirm.

h: Rotate the channel knob to select <SEND>. Press [CH/ENT] to send the distress alert- relay call.

◇ Receiving a Geographical Area Call Distress Alert

Refer to Section 4.1.3 for distress alert reception operations. The screen will display the interface shown in Figure 4.2. 2.

RCV REALAY GEOGRAPHIC		00H00M02S
FROM MMSI :	666666666	< CONNECT >
DIST MMSI :	888888888	
NATURE :	UNDESIGNATED	
COMM M/F :	TELEPHONE / 8291.0KHz	
POSITION :	99°99 . 9999 *	USB HIGH
	999°99 . 9999 * . 88:88 Utc	Rx: 0000000000
		Tx: 0000000000
RX FREQ :	8414.5kHz	
<div style="display: flex; justify-content: space-around;"> SW-FREQ RELAY ACK PRINT CLOSE </div>		

Figure 4.2.2

◇ Relaying a Distress Alert to an Individual Vessel

- a: Press the [CALL] key on the panel to open the call type list.
- b: Use the channel knob to select <DISTRESS RELAY INDIVIDUAL MSG>, then press [CH/ENT] to open the editing interface, as shown in Figure 4.2.3.

DISTRESS RELAY INDIVIDUAL MSG	
TO MMSI :	-----
DIST MMSI :	-----
NATURE :	UNDESIGNATED
COMM M/F :	TELEPHONE / 8291.0KHz
POSITION :	99°99 . 9999 " N
	999°99 . 9999 " E / 88:88 Utc
TX FREQ :	8414.5kHz
<div style="display: flex; justify-content: space-around;"> SEND CLOSE </div>	

Figure 4.2.3

- c: Rotate the channel knob to select <TO MMSI>(Target Vessel). Use the numeric keypad to enter the MMSI number of the Target vessel, or press [CH/ENT] to open the <SHIP ADDRLIST> and select the MMSI number from the directory.
- d: Rotate the channel knob to select <DIST MMSI>(Distressed Vessel). Use the numeric keypad to enter the MMSI number of the distressed vessel, or press [CH/ENT] to open the <SHIP ADDRLIST> and select the MMSI number from the directory.
- e: Rotate the channel knob to select <NATURE>(Distress Type). Distress categories include: Fire, Flooding, Collision, Grounding, Listing, Sinking, Adrift, Undesignated, Abandoning, Piracy, and Man Overboard—11 types in total. The default selection is "Undesignated." Press [CH/ENT] to confirm.
- f: Rotate the channel knob to select <POSITION>(Distress Position). Use the numeric keys to enter the distressed vessel's position coordinates. Rotate the [CLARITY] knob to adjust the cursor position.
- g: Rotate the channel knob to move the cursor to <TXFREQ>(Transmit Frequency). Press [CH/ENT] to open the DSC frequency selection dialog. There are three transmission modes:
 1. MULTI FREQ -> Multi-frequency transmission, where the distress call is sent on six frequencies.
 2. AUTO FREQ-> Automatic frequency transmission, where the distress call cycles through six frequencies at intervals of 3.5-4.5 minutes.
 3. Single frequency transmission, where the distress call is sent on the selected frequency.

- After selecting the mode, press [CH/ENT] to confirm.
- h: Rotate the channel knob to select <SEND>. Press [CH/ENT] to send the distress alert relay call.

◇ Receiving a Distress Alert Relay Acknowledgment Call to an Individual Vessel

Refer to Section 4.1.2 for distress alert acknowledgment reception operations. The screen will display the interface shown in Figure 4.2.4.

RCV RELAY INDIVIDUAL ACK		00H00M02S
FROM MMSI :	666666666	< CONNECT >
DIST MMSI :	888888888	
NATURE :	UNDESIGNATED	
COMM M/F :	TELEPHONE / 8291.0KHz	
POSITION :	99°99 . 9999 *	USB HIGH
	999°99 . 9999 * . 88:88 Utc	Rx: 0000000000
		Tx: 0000000000
RX FREQ :	8414.5kHz	
<div style="display: flex; justify-content: space-around;"> SW-FREQ PRINT CLOSE </div>		

Figure 4.2.4

◇ Receiving a Distress Alert Relay Call to an Individual Vessel

Refer to Section 4.1.3 for distress alert reception operations. The screen will display the interface shown in Figure 4.2.5.

RCV REALAY INDIVIDUAL		00H00M02S
FROM MMSI :	666666666	< CONNECT >
DIST MMSI :	888888888	
NATURE :	UNDESIGNATED	
COMM M/F :	TELEPHONE / 8291.0KHz	
POSITION :	99°99 . 9999 *	USB HIGH
	999°99 . 9999 * . 88:88 Utc	Rx: 0000000000
		Tx: 0000000000
RX FREQ :	8414.5kHz	
<div style="display: flex; justify-content: space-around;"> SW-FREQ RELAY ACK PRINT CLOSE </div>		

Figure 4.2.5

Routine Call Operation

※ DSC operations must be performed only when the device has a valid MMSI number. If there is no valid MMSI number, pressing the [DISTRESS] key and [CALL] key will trigger a warning message indicating the absence of an MMSI number. The following operations assume that the device has been configured with a valid MMSI number and is properly connected to a GNSS device.

◆ Individual Call

◇ Sending an Individual Call

- a: Press the [CALL] key on the panel to open the call type list.
- b: Use the channel knob to select <INDIVIDUAL MSG>, then press [CH/ENT] to open the editing interface, as shown in Figure 5.1.1.

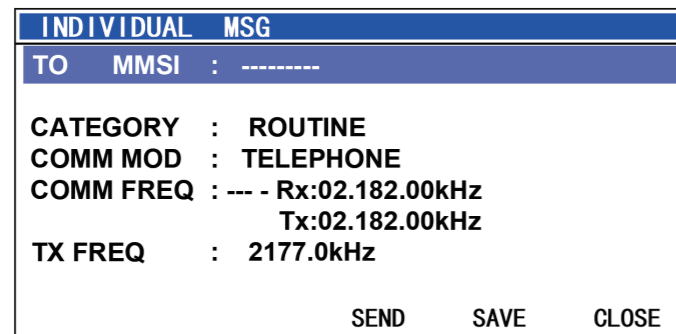

Figure 5.1.1

- c: Rotate the channel knob to select <TO MMSI>(Target Vessel). Use the numeric keypad to enter the MMSI number of the target vessel, or press [CH/ENT] to open the contacts list and select the MMSI number from the directory.
 - d: Rotate the channel knob to select <CATEGORY>(Call Type). Press [CH/ENT] to open the call type list, select the desired type, then press [CH/ENT] to confirm.
 - e: Rotate the channel knob to select <COMM FREQ>(Communication Frequency). Press [CH/ENT] to open the communication frequency type list, select either frequency information or position information, then press [CH/ENT] to return to the editing interface. Use the numeric keypad to enter the corresponding frequency or position data. Rotate the [CLARITY] knob to adjust the cursor position.
 - f: Rotate the channel knob to select <TX FREQ>(Transmit Frequency). Press [CH/ENT] to open the DSC frequency list, then press [CH/ENT] to confirm.
 - g: Rotate the channel knob to select <SEND>. Press [CH/ENT] to send the individual call.
 - h: After sending the individual call, the device will wait for an acknowledgment call. The user can select <Resend>, then press [CH/ENT] to retransmit the call.
- ※ Select <Save> to store the call in the call log.

◇ Receiving an Individual Acknowledgment Call

When the device receives an individual acknowledgment call, an alert sound will be emitted. The acknowledgment call information will be displayed, as shown in Figure 5.1.2. At the same time, the device will automatically switch to the relevant communication frequency and wait for further communication.

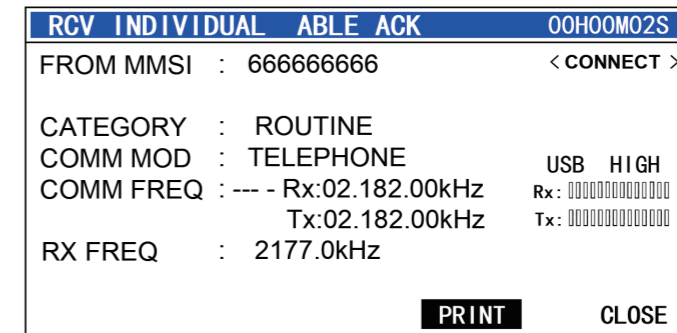

Figure 5.1.2

- Select <PRINT>, then press [CH/ENT] to print the call record.
- Select <CLOSE>, then press [CH/ENT] to exit the interface and return to the main menu.

◇ Receiving an Individual Call

When the device receives an individual call, an alert sound will be emitted, and the call information will be displayed, as shown in Figure 5.1.3.

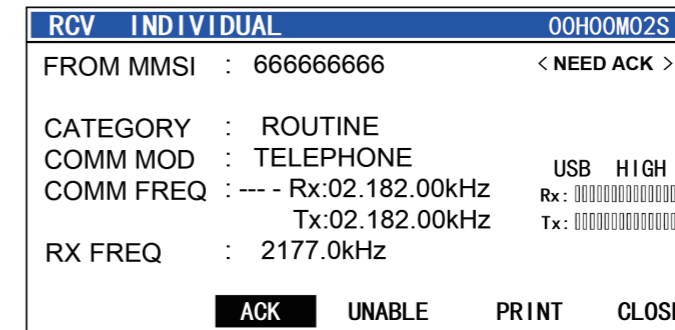

Figure 5.1.3

- If a response is required, select <ACK>, then press [CH/ENT] to send an acknowledgment call. If a partial acknowledgment is needed, select <UNABLE>, then press [CH/ENT] to open the partial acknowledgment reason dialog. Choose the appropriate reason, then press [CH/ENT] to confirm and send the partial acknowledgment call.
- Select <PRINT>, then press [CH/ENT] to print the call record.
- Select <CLOSE>, then press [CH/ENT] to exit the interface and return to the main menu.

◆ Geographical Area Call

◇ Sending a Geographical Area Call

- a: Press the [CALL] key on the panel to open the call type list.
- b: Use the channel knob to select <GEOGRAPHIC MSG>(Geographical Area Call), then press [CH/ENT] to open the editing interface, as shown in Figure 5.2.1.



Figure 5.2.1

- c: Rotate the channel knob to select <AREA>(Call Area). Press [CH/ENT] to open the area type selection dialog. Choose the desired area type, then press [CH/ENT] to confirm. Use the numeric keys to enter area information. Rotate the [CLARITY] knob to adjust the cursor position.
 - d: Rotate the channel knob to select <CATEGORY>(Call Type). Press [CH/ENT] to open the call type list, select the desired type, then press [CH/ENT] to confirm.
 - e: Rotate the channel knob to select <COMM REQ>(Communication Frequency). Use the numeric keypad to enter the corresponding frequency or position data. Rotate the [CLARITY] knob to adjust the cursor position.
 - f: Rotate the channel knob to select <TX FREQ>(Transmit Frequency). Press [CH/ENT] to open the DSC frequency list, then press [CH/ENT] to confirm.
 - g: Rotate the channel knob to select <SEND>. Press [CH/ENT] to send the geographical area call.
 - h: After sending the geographical area call, the device will switch to the communication frequency and prepare for transmission. The user can also select <RESEND>, then press [CH/ENT] to retransmit the call.
- ※ Select <SAVE> to store the call in the call log.

◇ Receiving a Geographical Area Call

When the device receives a geographical area call, an alert sound will be emitted, and the call information will be displayed, as shown in Figure 5.2.2.

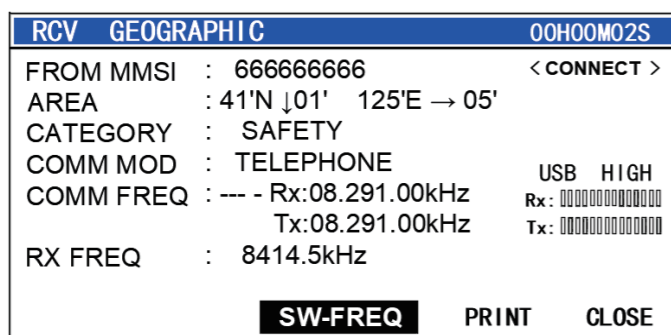

Figure 5.2.2

If the frequency switching setting in the digital selective calling menu is set to automatic, the device will automatically switch frequencies upon receiving a call. Otherwise, when a call is received, the device's current frequency will not switch to the communication frequency, requiring the user to select <SW-FREQ>(Change Frequency) and press [CH/ENT] to switch to the communication frequency. Select <PRINT> and press [CH/ENT] to print the call record. Select <CLOSD> and press [CH/ENT] to exit the interface and return to the main menu.

◆ Group Call

◇ Sending a Group Call

- a: Press the [CALL] key on the panel to open the call type list.
- b: Use the channel knob to select <GROUP MSG>(Group Call), then press [CH/ENT] to open the editing interface, as shown in Figure 5.3.1.

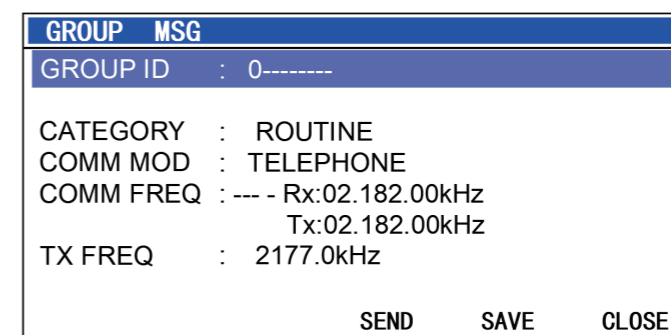

Figure 5.3.1

- c: Rotate the channel knob to select <GROUP ID>. Use the numeric keypad to enter the group ID number, or press [CH/ ENT] to open the contacts list and select the group ID number from the directory.
 - d: Rotate the channel knob to select <CATEGORY>(Call Type). Press [CH/ENT] to open the call type list, select the desired type, then press [CH/ENT] to confirm.
 - e: Rotate the channel knob to select <COMM MOD>(Communication Frequency). Use the numeric keypad to enter the corresponding frequency or position data. Rotate the [CLARITY] knob to adjust the cursor position.
 - f: Rotate the channel knob to select <TX FREQ>(Transmit Frequency). Press [CH/ENT] to open the DSC frequency list, then press [CH/ENT] to confirm.
 - g: Rotate the channel knob to select <SEND>. Press [CH/ENT] to send the group call.
 - h: After sending the group call, the device will switch to the communication frequency and prepare for transmission. The user can also select <RESEND>, then press [CH/ENT] to retransmit the call.
- ※ Group calls are limited to routine calls.
※ Select <SAVE> to store the call in the call log.

◇ Receiving a Group Call

When the device receives a group call, an alert sound will be emitted, and the call information will be displayed, as shown in Figure 5.3.2.

RCV GROUP		00H00M02S
FROM MMSI	: 666666666	<CONNECT >
GROUP ID	: 055555555	
CATEGORY	: ROUTINE	
COMM MOD	: TELEPHONE	USB HIGH
COMM FREQ	: --- - Rx:02.182.00kHz	Rx: 000000000000
	Tx:02.182.00kHz	Tx: 000000000000
RX FREQ	: 2177.0kHz	
SW-FREQ		PRINT CLOSE

Figure 5.3.2

If the frequency switching setting in the digital selective calling menu is set to automatic, the device will automatically switch frequencies upon receiving a call. Otherwise, when a call is received, the device's current frequency will not switch to the communication frequency, requiring the user to select <SW-FREQ>(Change Frequency) and press [CH/ENT] to switch to the communication frequency.

Select <PRINT> and press [CH/ENT] to print the call record

Select <CLOSE> and press [CH/ENT] to exit the interface and return to the main menu.

◆ PSTN Call

◇ Sending a PSTN Call

a: Press the [CALL] key on the panel to open the call type list.

b: Use the channel knob to select <PSTN MSG>, then press [CH/ENT] to open the editing interface, as shown in Figure 5.4.1.

PSTN MSG	
TO MMSI	: 00-----
TELE.NO	: -----
CATEGORY	: ROUTINE
COMM MOD	: TELEPHONE
COMM FREQ	: --- - Rx:02.182.00kHz
	Tx:02.182.00kHz
TX FREQ	: 2177.0kHz
SEND SAVE CLOSE	

Figure 5.4.1

- c: Rotate the channel knob to select <TO MMSI>(Target). Use the numeric keypad to enter the MMSI number of the target, or press [CH/ENT] to open the coast address list and select the MMSI number from the directory.
 - d: Rotate the channel knob to select <TELE NO>(Telephone Number). Use the numeric keypad to enter the phone number to be dialed, or press [CH/ENT] to open the contacts list and select a phone number.
 - e: Rotate the channel knob to select <TX FREQ>(Transmit Frequency). Press [CH/ENT] to open the DSC frequency list, then press [CH/ENT] to confirm.
 - f: Rotate the channel knob to select <SEND>. Press [CH/ENT] to send the telephone call.
 - g: After sending the PSTN Call , the device will wait for an acknowledgment call. The user can select <RESEND>, then press [CH/ENT] to retransmit the call.
- ※ Select <SAVE> to store the call in the call log.

◇ Receiving a PSTN Acknowledgment Call

When the device receives a PSTN acknowledgment call, an alert sound will be emitted. The acknowledgment call information will be displayed, as shown in Figure 5.4.2. At the same time, the device will automatically switch to the relevant communication frequency and wait for further communication.

RCV PSTN ABL ACK		00H00M02S
FROM MMSI	: 005555555	<CONNECT >
TELE.NO	: 02167890123	
CATEGORY	: ROUTINE	
COMM MOD	: TELEPHONE	USB HIGH
COMM FREQ	: --- - Rx:02.182.00kHz	Rx: 000000000000
	Tx:02.182.00kHz	Tx: 000000000000
RX FREQ	: 2177.0kHz	
PRINT		CLOSE

Figure 5.4.2

Select <PRINT>, then press [CH/ENT] to print the call record.

Select <CLOSE>, then press [CH/ENT] to exit the interface and return to the main menu.

◇ Receiving a PSTN Call

When the device receives a PSTN call, an alert sound will be emitted, and the call information will be displayed, as shown in Figure 5.4.3.

RCV PSTN		00H00M02S
FROM MMSI	: 005555555	< NEED ACK >
TELE.NO	: 02167890123	
CATEGORY	: ROUTINE	
COMM MOD	: TELEPHONE	USB HIGH
COMM FREQ	: --- - Rx:02.182.00kHz	Rx: 000000000000
	Tx:02.182.00kHz	Tx: 000000000000
RX FREQ	: 2177.0kHz	
ACK UNABLE PRINT CLOSE		

Figure 5.4.3

If a response is required, select <ACK>, then press [CH/ENT] to send an acknowledgment call.
 If a partial acknowledgment is needed, select <UNABLE>, then press [CH/ENT] to open the partial acknowledgment reason dialog. Choose the appropriate reason, then press [CH/ENT] to confirm and send the partial acknowledgment call.
 Select <PRINT>, then press [CH/ENT] to print the call record.
 Select <CLOSE>, then press [CH/ENT] to exit the interface and return to the main menu.

◆ Position Request Call

◇ Sending a Position Request Call

a: Press the [CALL] button on the panel to open the call type list.
 b: Use the channel knob to select <POSITION MSG> (Position Request Call) and press [CH/ENT] to open the editing interface, as shown in Figure 5.5.1.

POSITION MSG	
TO MMSI	: -----
CATEGORY	: SAFETY
TX FREQ	: 8414.5kHz
SEND SAVE CLOSE	

Figure 5.5.1

c: Rotate the channel knob to select <TO MMSI>(Target). Use the numeric keypad to enter the MMSI number of the target, or press [CH/ENT] to open the coast address list and select the MMSI number from the directory.
 d: Rotate the channel knob to select <TELE NO>(Telephone Number). Use the numeric keypad to enter the phone number to be dialed, or press [CH/ENT] to open the contacts list and select a phone number.
 e: Rotate the channel knob to select <TX FREQ>(Transmit Frequency). Press [CH/ENT] to open the DSC frequency list, then press [CH/ENT] to confirm.
 f: Rotate the channel knob to select <SEND>. Press [CH/ENT] to send the telephone call.
 g: After sending the PSTN Call, the device will wait for an acknowledgment call. The user can select <RESEND>, then press [CH/ENT] to retransmit the call.
 ※ Select <SAVE> to store the call in the call log.

◇ Receiving a Position Acknowledge Call

When the device receives a position acknowledge call, it emits a notification sound and displays the acknowledge call information, as shown in Figure 5.5.2.

RCV POSITION ACK		00H00M02S
FROM MMSI	: 666666666	
CATEGORY	: SAFETY	
POSITION	: 99°99 . 9999 " N	
	999°99 . 9999 " E / 88:88 Utc	
RX FREQ	: 8414.5kHz	
ACK PRINT CLOSE		

Figure 5.5.2

Select <PRINT>, then press [CH/ENT] to print the call record.
 Select <CLOSE>, then press [CH/ENT] to exit the interface and return to the main menu.

◇ Receiving a Position Request Call

When the device receives a position request call, it emits a notification sound and displays the call information, as shown in Figure 5.5.3.

RCV POSITION REQ		00H00M02S
FROM MMSI	: 666666666	< NEED ACK >
CATEGORY	: SAFETY	
RX FREQ	: 8414.5kHz	
ACK PRINT CLOSE		

Figure 5.5.3

Select **<ACK>** and press **[CH/ENT]** to send an acknowledge call.
 Select **<PRINT>** and press **[CH/ENT]** to print the call details.
 Select **<CLOSE>** and press **[CH/ENT]** to exit the interface and return to the main menu.

◆ **Test Call**

◇ **Sending a Test Call**

a: Press the **[CALL]** button on the panel to open the call type list.
 b: Use the channel knob to select **<TEST MSG>** (Test Call) and press **[CH/ENT]** to open the editing interface, as shown in Figure 5.6.1.
 c: Turn the channel knob to select **<TO MMSI>**(Call Target), enter the target vessel's MMSI number using the numeric keypad, or press **[CH/ENT]** to open the contact list and select an MMSI number from it.

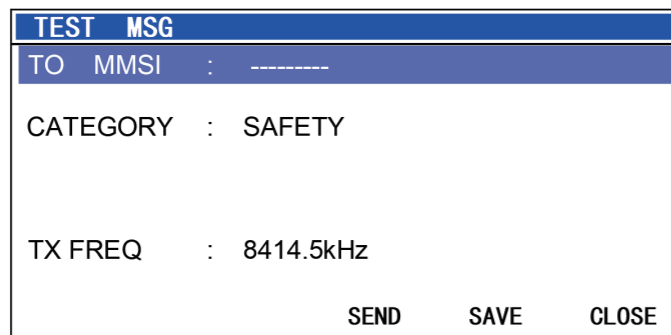

Figure 5.6.1

d: Turn the channel knob to select **<TX FREQ>**(Transmission Frequency), press **[CH/ENT]** to open the DSC frequency list, then press **[CH/ENT]** again to confirm.
 e: Turn the channel knob to select **<SEND>**, press **[CH/ENT]** to send the call.
 f: After sending the test call, the device waits for an acknowledge call. The user can select **<RESEND>** and press **[CH/ENT]** to send the call again.
 ※ **Select <SAVE> to store the call in the call log.**

◇ **Receiving a Test Acknowledge Call**

When the device receives a test acknowledge call, it emits a notification sound and displays the response call information, as shown in Figure 5.6.2.

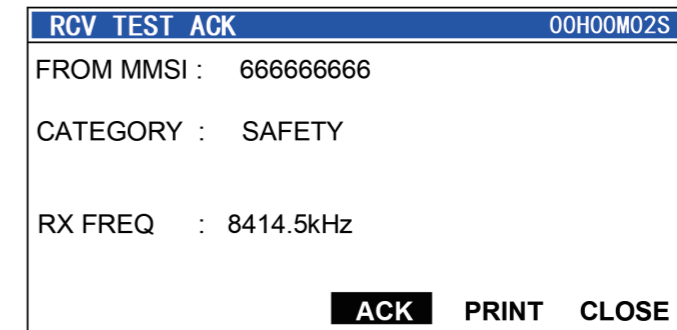

Figure 5.6.2

Select **<PRINT>**, then press **[CH/ENT]** to print the call record.
 Select **<CLOSE>**, then press **[CH/ENT]** to exit the interface and return to the main menu.

◇ **Receiving a Test Call**

When the device receives a test call, it emits a notification sound and displays the call information, as shown in Figure 5.6.3.

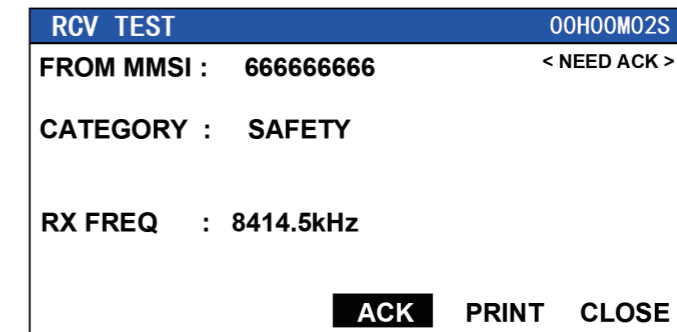

Figure 5.6.3

Select **<ACK>** and press **[CH/ENT]** to send an acknowledge call.
 Select **<PRINT>** and press **[CH/ENT]** to print the call details.
 Select **<CLOSE>** and press **[CH/ENT]** to exit the interface and return to the main menu.

◆ Neutral Craft Call

※ Neutral craft calls can only be sent when the special call function is enabled.

Refer to the menu operation for enabling special calls.

Press the [CALL] button on the panel to open the call type list and select <NEUTRAL MSG>(Neutral Craft Call).

Refer to Section 5.2 of this manual for maritime area call operations.

The display interface for neutral craft calls is shown in Figures 5.7.1 and 5.7.2.

Neutral craft calls are classified solely as safety calls.

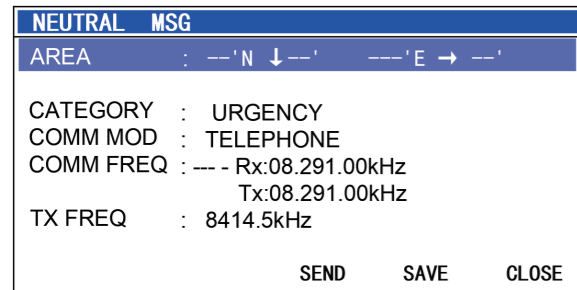

Figures 5.7.1

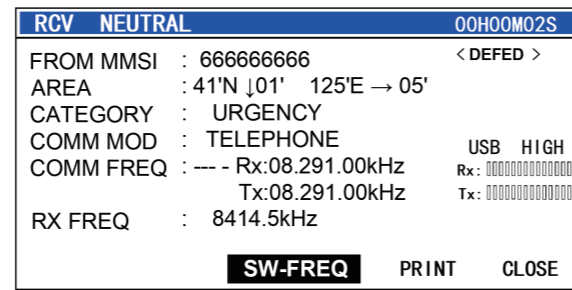

Figures 5.7.2

◆ Medical Transport Call

※ Medical transport calls can only be sent when the special call function is enabled.

Refer to the menu operation for enabling special calls.

Press the [CALL] button on the panel to open the call type list and select <MEDICAL MSG>(Medical Transport Call). Refer to Section 5.2 of this manual for maritime area call operations.

The display interface for medical transport calls is shown in Figures 5.8.1 and 5.8.2. Medical transport calls are classified solely as safety calls.

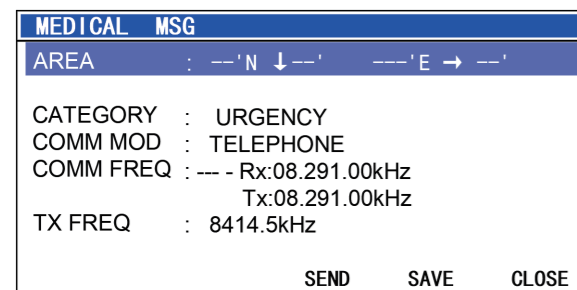

Figures 5.8.1

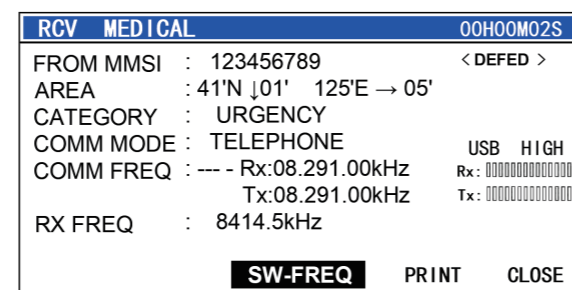

Figures 5.8.2

◆ Polling Call

When the device receives a polling call, it emits a notification sound and displays the call information, as shown in Figure 5.9.1

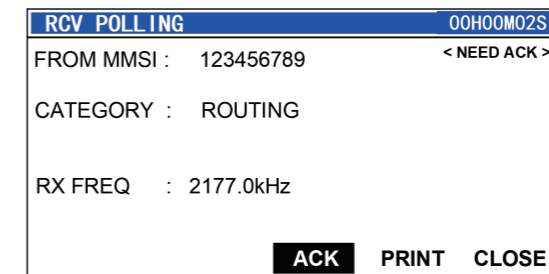

Figure 5.9.1

Select <ACK> and press [CH/ENT] to send an acknowledge call.

Select <PRINT> and press [CH/ENT] to print the call details.

Select <CLOSE> and press [CH/ENT] to exit the interface and return to the main menu.

Menu Operation

◆ Use the Menu

Press the [MENU] button on the panel to open the main menu, as shown in Figure 6.1.
Turn the channel knob to select the submenu to enter, then press [CH/ENT] to confirm and access the submenu.
Press [CE] to return to the previous menu level.

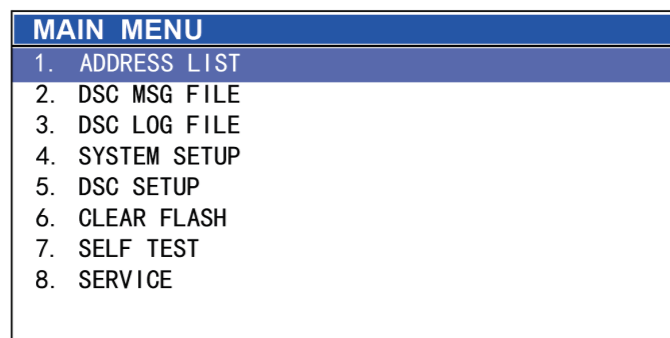

Figure 6.1

◆ Address List

The device allows operators to store 30 vessel entries, 30 shore station entries, 30 group MMSI numbers, and 30 telephone numbers, facilitating quick entry of target MMSI numbers during CALL transmission.

How to Add/Edit an Entry:

- a: In the main menu, select <ADDRESS LIST> and press [CH/ENT] to open the contact list. Choose the entry type to edit, then press [CH/ENT] to access the contact list interface.
- b: Turn the channel knob to select the entry to edit and press [CH/ENT] to open the entry operation dialog, as shown in Figure 6.2.1.
- c: Turn the channel knob to select <EDIT SELECTED ITEM MSG> and press [CH/ENT] to open the "Edit Item MSG" dialog, as shown in Figure 6.2.2. Use the numeric keypad to enter the entry name and number. You can use [CLARITY] and [CH/ENT] knobs to move the cursor below the characters.
- d: Once the information is entered, turn the channel knob to <SAVE>, then press [CH/ENT] to confirm the save.

How to Delete an Entry:

- In Step b above, when the entry operation dialog is open, turn the channel knob to select <DELETE SELECT ITEM MSG> or <DELETE ALL ITEM MSG>.
- Press [CH/ENT] to delete the corresponding entries.

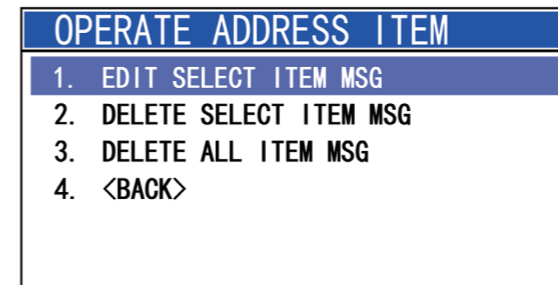

Figure 6.2.1

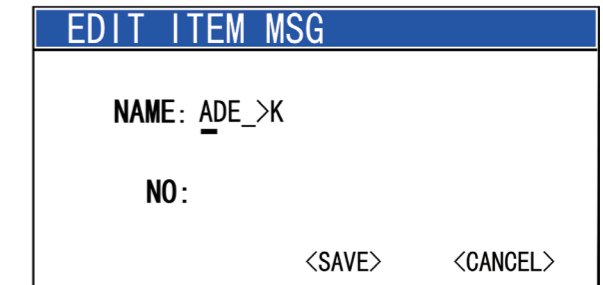

Figure 6.2.2

◆ Call File

The device can store up to 50 pre-edited standard calls. Refer to Section 5, "Routine Call Operation" for call editing methods.

- a: In the main menu, select <DSC MSG FILE> and press [CH/ENT] to open the call file.
- b: Turn the channel knob to select the call to operate on, then press [CH/ENT] to open the call file operation dialog, as shown in Figure 6.3.

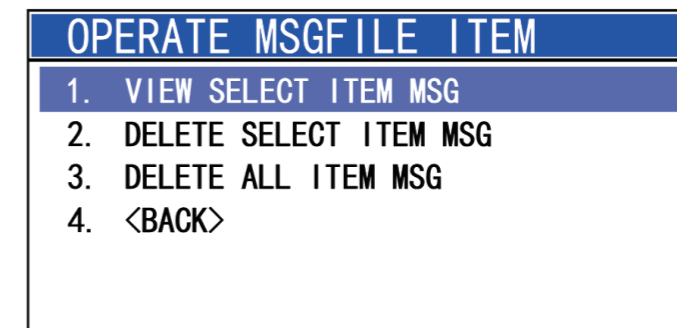

Figure 6.3

- c: Turn the channel knob to select the desired operation.
- d: Press [CE] to close the call file.
- ※In the call file viewing interface, you can select <SEND> to transmit the selected call.

◆ Call Log

The device can store both transmitted and received emergency and standard calls, up to 100 entries each.

- a: In the main menu, select <DSC LOG FILE> and press [CH/ENT] to open the call log list.
- b: Turn the channel knob to select the call type to view, then press [CH/ENT] to open the corresponding call log file.
- c: Turn the channel knob to select the call to operate on, then press [CH/ENT] to open the call log operation dialog, as shown in Figure 6.4.

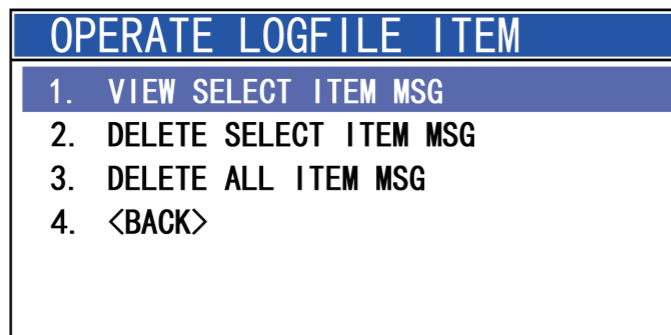

Figure 6.4

d: Turn the channel knob to select the desired operation.

e: Press [CE] to close the call log file.

◆ System Setup

◇ Local Time Settings

The device is equipped with an RTC (Real-Time Clock) module. When there is no GNSS connection, the internal RTC starts working, generating local date and time.

How to Set the Internal RTC:

- a: In the "SYSTEM SETUP" menu, select <TIME RTC> and press [CH/ENT] to open the local time settings dialog, as shown in Figure 6.5.1.
- b: Use the numeric keypad to enter the date and time information. You can also turn the channel knob to move the cursor and adjust individual digits.
- Once the input is complete, select <SAVE> and press [CH/ENT] to save the time information.

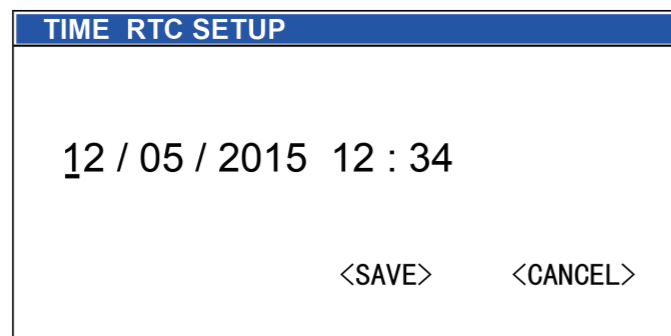

Figure 6.5.1

◇ Time Offset Settings

When the device receives valid GNSS data, it can calculate local time based on UTC and display it on the main interface using the formula: RTC = UTC + Time Offset.

How to Set the Time Offset:

- a: In the "SYSTEM SETUP" menu, select <TIME DIFF> and press [CH/ENT] to open the time offset settings dialog, as shown in Figure 6.5.2.1.
- b: Press [CH/ENT] to open the time offset list, as shown in Figure 6.5.2.2.
- c: Turn the channel knob to select the desired time offset, then press [CH/ENT] to confirm.
- d: Press [CE] to return to the "SYSTEM SETUP" menu.

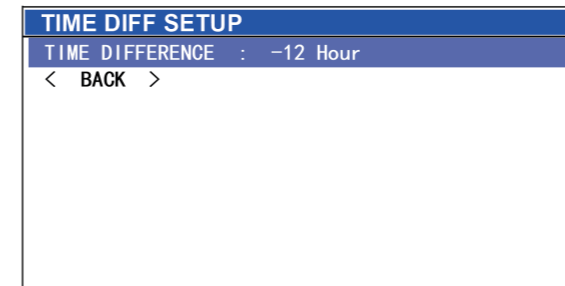

Figure 6.5.2.1

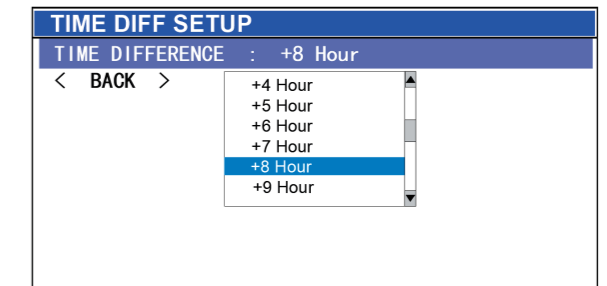

Figure 6.5.2.2

◇ Timeout Settings

When the operator holds the PTT button beyond the set time, the device will automatically shut off the transmitter to terminate transmission. The default factory setting is 5 minutes.

How to Set the Timeout Duration:

- a: In the "SYSTEM SETUP" menu, select <TIME OUT> and press [CH/ENT] to open the timeout settings dialog, as shown in Figure 6.5.3.1.
- b: Press [CH/ENT] to open the timeout duration list, as shown in Figure 6.5.3.2.
- c: Turn the channel knob to select the desired timeout duration, then press [CH/ENT] to confirm.
- d: Press [CE] to return to the "SYSTEM SETUP" menu.

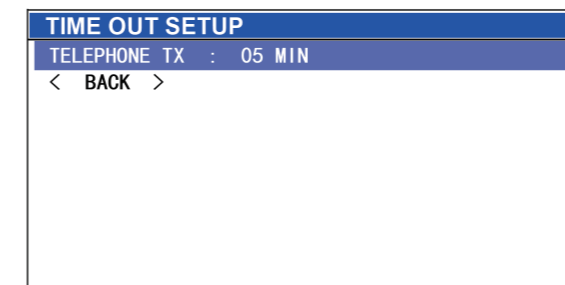

Figure 6.5.3.1

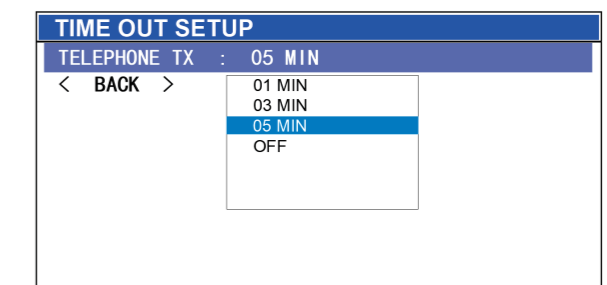

Figure 6.5.3.2

◇ **Speaker Settings**

The device has a built-in speaker on the front panel and also supports an external speaker, allowing users to choose according to their needs.

How to Configure Speaker Settings:

- a: In the "SYSTEM SETUP" menu, select <SPEAKER> and press [CH/ENT] to open the speaker settings dialog, as shown in Figure 6.5.4.1.
- b: Press [CH/ENT] to open the speaker type list, as shown in Figure 6.5.4.2.
- c: Turn the channel knob to select the desired speaker type, then press [CH/ENT] to confirm.
- d: Press [CE] to return to the "SYSTEM SETUP" menu.

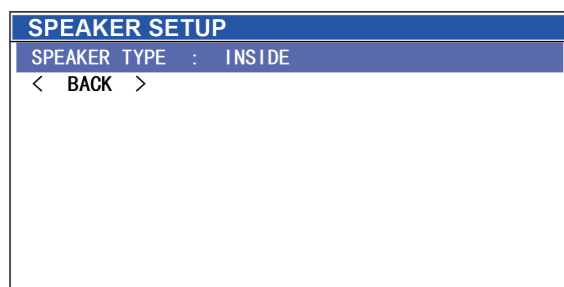

Figure 6.5.4.1

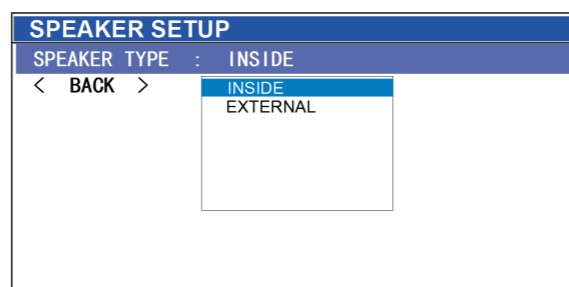

Figure 6.5.4.2

◇ **Language Settings**

The device supports both Chinese and English display.

How to Set the Language:

- a: In the "SYSTEM SETUP" menu, select <LANGUAGE> and press [CH/ENT] to open the language selection dialog, as shown in Figure 6.5.5.1.
- b: Press [CH/ENT] to open the language type list, as shown in Figure 6.5.5.2.
- c: Turn the channel knob to select the desired language, then press [CH/ENT] to confirm and return to the main interface.

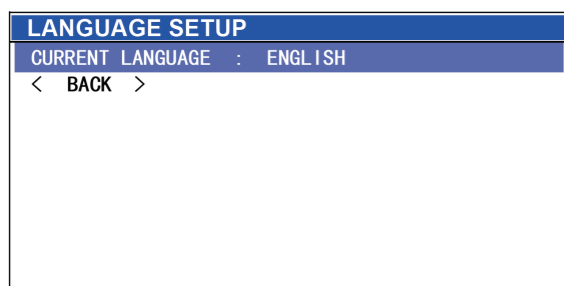

Figure 6.5.5.1

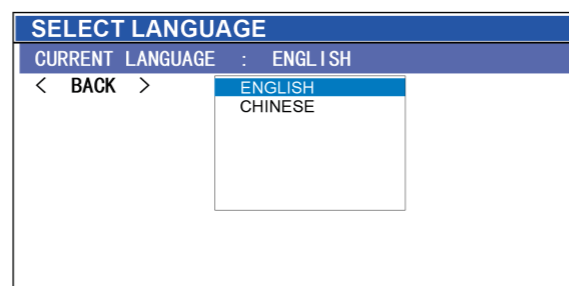

Figure 6.5.5.2

◇ **Audio Settings**

The device allows users to disable keypad tones and error alert sounds.

How to Configure Sound Settings:

- a: In the "SYSTEM SETUP" menu, select <AUDIO> and press [CH/ENT] to open the sound settings dialog, as shown in Figure 6.5.6.1.
- b: Turn the channel knob to select the sound type to adjust, then press [CH/ENT] to open the status list, as shown in Figure 6.5.6.2.
- c: Turn the channel knob to select the desired status, then press [CH/ENT] to confirm.
- d: Press [CE] to return to the "SYSTEM SETUP" menu.

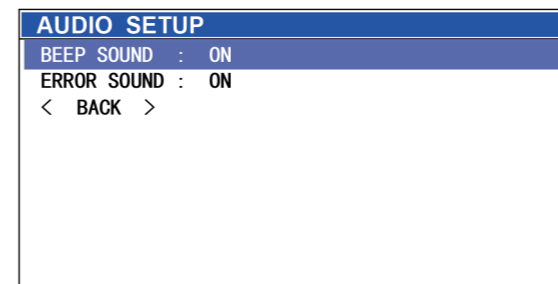

Figure 6.5.6.1

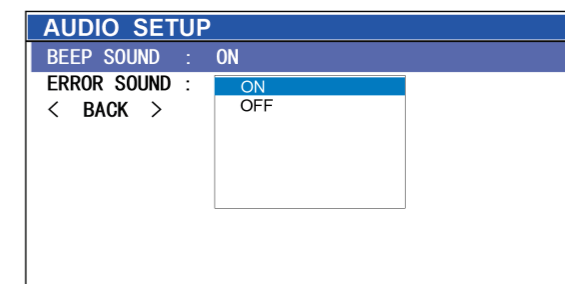

Figure 6.5.6.2

◇ **Antenna Tuning Settings**

a: In the "SYSTEM SETUP" menu, select <ATU TYPE> and press [CH/ENT] to open the antenna tuning settings dialog, as shown in Figure 6.5.7.1.

- b: Press [CH/ENT] to open the antenna tuning type list, as shown in Figure 6.5.7.2.
- c: Turn the channel knob to select the desired type, then press [CH/ENT] to confirm.
- d: Press [CE] to return to the "SYSTEM SETUP" menu.

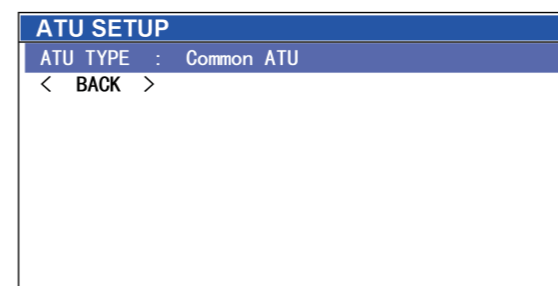

Figure 6.5.7.1

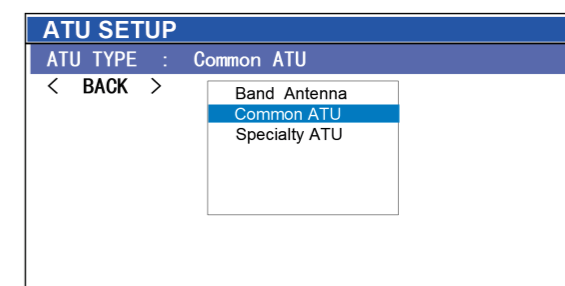

Figure 6.5.7.2

- ※ The actual connected antenna tuner must match the type set in this menu.
- ※ If connected to an AT-500, set the tuner type to "Common ATU."
- ※ If connected to an AT-131/141, set the tuner type to "Specialty ATU"
- ※ A general antenna tuner does not require tuning signal lines (START, KEY).

◇ **Power Settings (Available in Korea Region Only)**

- a: In the "SYSTEM SETUP" menu, select <POWER <Only Korea>> and press [CH/ENT] to open the power settings dialog, as shown in Figure 6.5.8.1.
- b: Enter the modification password "199707" and press [CH/ENT], as shown in Figure 6.5.8.2.
- c: Press [CH/ENT] to open the power range list, then select the desired power range and press [CH/ENT] to confirm.
- d: Press [CE] to return to the "SYSTEM SETUP" menu.

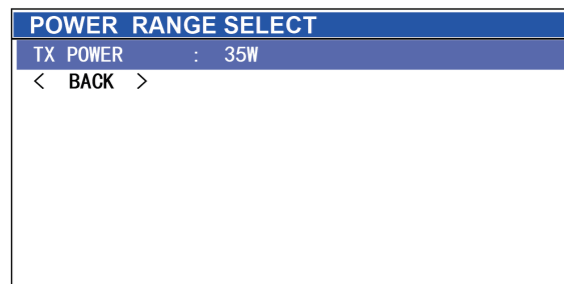

Figure 6.5.8.1

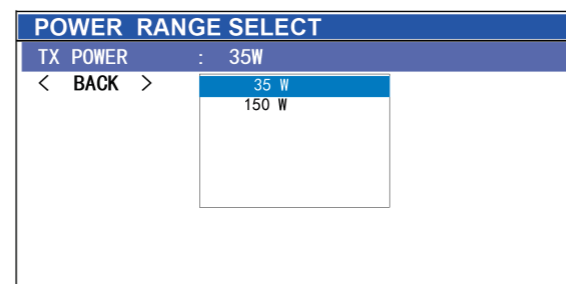

Figure 6.5.8.2

◇ **Baud Rate Settings**

- a: In the "SYSTEM SETUP" menu, select <COM RATE> and press [CH/ENT] to open the communication speed settings dialog, as shown in Figure 6.5.9.1.
- b: Turn the channel knob to select the speed setting option, then press [CH/ENT] to open the speed list, as shown in Figure 6.5.9.2.
- c: Turn the channel knob to select the desired speed, then press [CH/ENT] to confirm.
- d: Press [CE] to return to the "SYSTEM SETUP" menu.

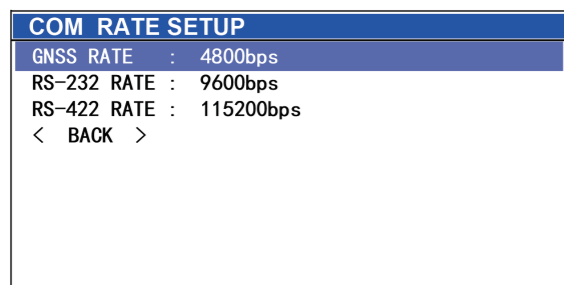

Figure 6.5.9.1

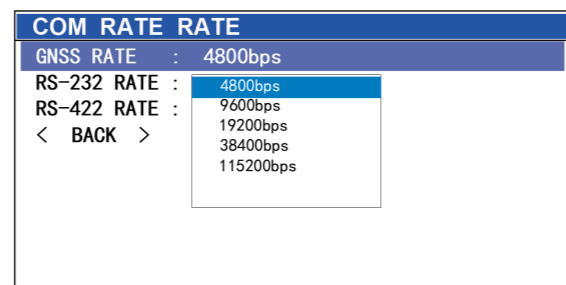

Figure 6.5.9.2

※ When connecting to GNSS, it is essential to select the corresponding speed. Generally, GPS input speed is ** 4800bps**, while BeiDou input speed is **9600bps**.

◇ **Display Mode Settings**

- a: In the "SYSTEM SETUP" menu, select <DISP MODE> and press [CH/ENT] to open the display mode settings dialog, as shown in Figure 6.5.10.1.
- b: Turn the channel knob to select the desired setting option, then press [CH/ENT] to open the mode list, as shown in Figure 6.5.10.2.
- c: Turn the channel knob to select the mode, then press [CH/ENT] to confirm.
- d: Press [CE] to return to the "SYSTEM SETUP" menu.

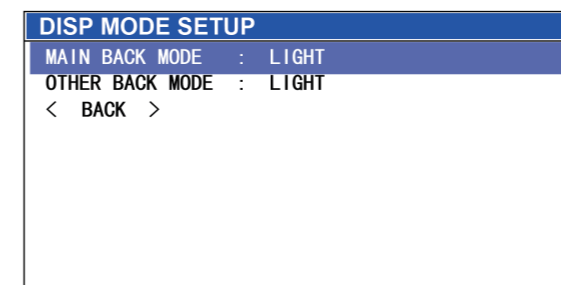

Figure 6.5.10.1

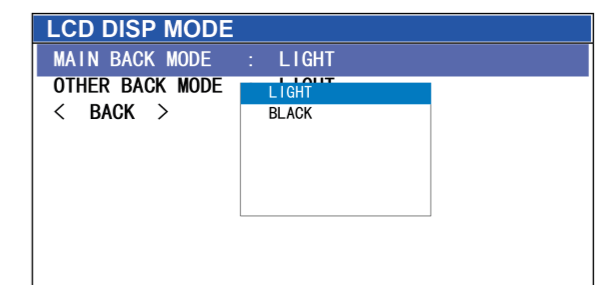

Figure 6.5.10.2

◆ **Digital Selective Calling (DSC) Settings**

◇ **Local MMSI Settings**

- The device allows users to change the local MMSI number up to 3 times. After three changes, a modification password must be entered to continue MMSI updates.
- a: In the "DSC SETUP" menu, select <MMSI> and press [CH/ENT] to open the MMSI settings dialog, as shown in Figure 6.6.1.
 - b: Use the numeric keypad to enter the MMSI number. Turn the channel knob to move the cursor and modify the digits as needed. Once the input is complete, select <SAVE> and press [CH/ENT] to store the MMSI information.
 - c: Press [CE] to return to the "DSC SETUP" menu.

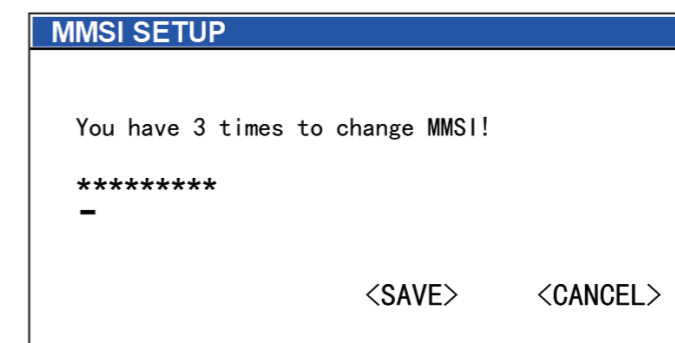

Figure 6.6.1

◇ Position Settings

When no external GNSS is connected, the device allows users to manually enter GNSS information.

- a: In the "DSC SETUP" menu, select <GNSS INFO> and press [CH/ENT] to open the position settings dialog, as shown in Figure 6.6.2.
- b: Use the numeric keypad to input GNSS data. Turn the channel knob to move the cursor and modify the digits as needed. Once the input is complete, select <SAVE> and press [CH/ENT] to store the GNSS information.
- c: Press [CE] to return to the "DSC SETUP" menu.

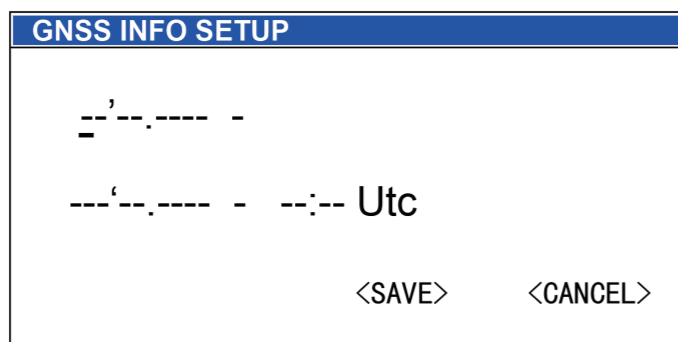

Figure 6.6.2

◇ Acknowledge Settings

The device allows users to configure the call acknowledge mode. By default, all calls require manual acknowledgment.

- a: In the "DSC SETUP" menu, select <ACK> and press [CH/ENT] to open the acknowledge settings dialog, as shown in Figure 6.6.3.1.
- b: Turn the channel knob to select the call type to configure, then press [CH/ENT] to open the acknowledge mode list, as shown in Figure 6.6.3.2.
- c: Turn the channel knob to select the desired acknowledge mode, then press [CH/ENT] to confirm.
- d: Press [CE] to return to the "DSC SETUP" menu.

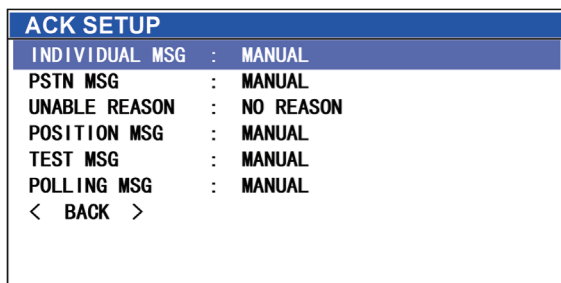

Figure 6.6.3.1

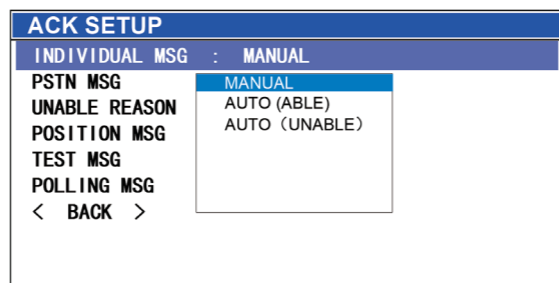

Figure 6.6.3.2

◇ Print Settings

The device supports connection to a serial printer (specific models required—consult the supplier). Users can configure the printing mode as either "AUTO" or "MANUAL". The default setting is manual printing.

- a: In the "DSC SETUP" menu, select <PRINT> and press [CH/ENT] to open the print settings dialog, as shown in Figure 6.6.4.1.
- b: Turn the channel knob to select the call type for printing, then press [CH/ENT] to open the status list, as shown in Figure 6.6.4.2.
- c: Turn the channel knob to select the desired print mode, then press [CH/ENT] to confirm.
- d: Press [CE] to return to the "DSC SETUP" menu.

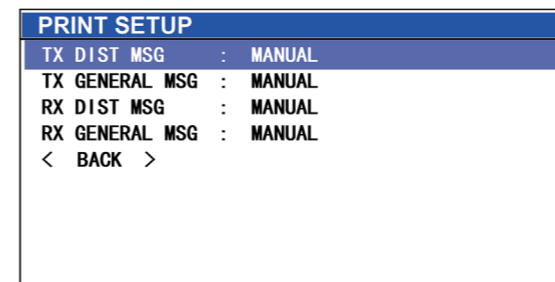

Figure 6.6.4.1

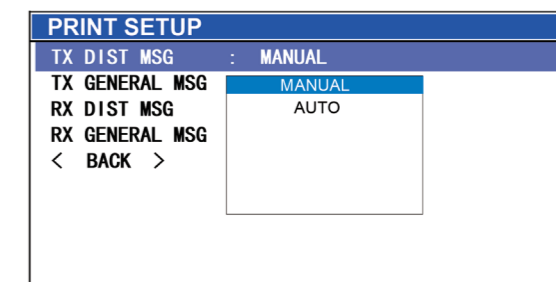

Figure 6.6.4.2

◇ Frequency Conversion Settings

When the device receives a routine call, users can configure the frequency conversion mode, choosing between "AUTO" and "MANUAL".

By default, "routine call" and "safety call" require manual mode, while "Urgency call"(Distress) use automatic mode.

- a: In the "DSC SETUP" menu, select <SWITCH> and press [CH/ENT] to open the frequency conversion settings dialog, as shown in Figure 6.6.5.1.
- b: Turn the channel knob to select the call type to configure, then press [CH/ENT] to open the conversion mode list, as shown in Figure 6.6.5.2.
- c: Turn the channel knob to select the desired conversion mode, then press [CH/ENT] to confirm.
- d: Press [CE] to return to the "DSC SETUP" menu.

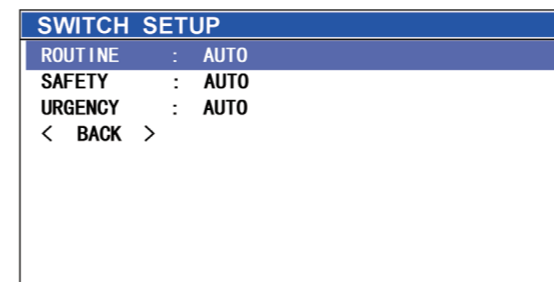

Figure 6.6.5.1

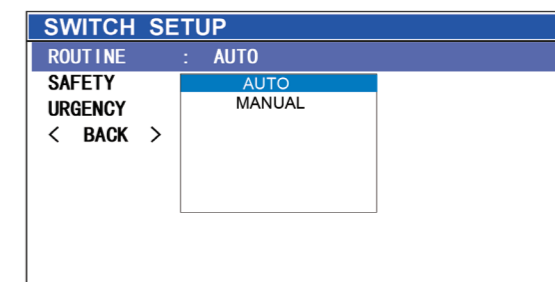

Figure 6.6.5.2

◇ **Special Call Settings**

Special calls include "Neutral Craft Calls" and "Medical Transport Calls". By default, "UNABLE", but users can enable them in this menu.

- a: In the "DSC SETUP" menu, select <SPECIAL CALL > and press [CH/ENT] to open the special call settings dialog, as shown in Figure 6.6.6.1.
- b: Turn the channel knob to select the call type to configure, then press [CH/ENT] to open the special call status list, as shown in Figure 6.6.6.2.
- c: Turn the channel knob to set the enable status for special calls, then press [CH/ENT] to confirm.
- d: Press [CE] to return to the "DSC SETUP" menu.

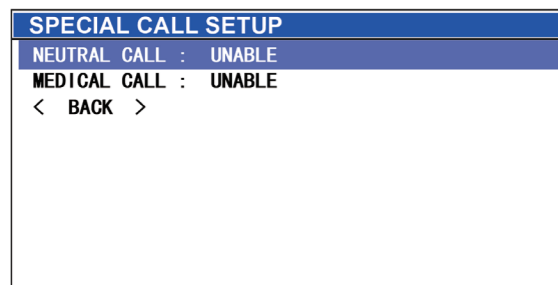

Figure 6.6.6.1

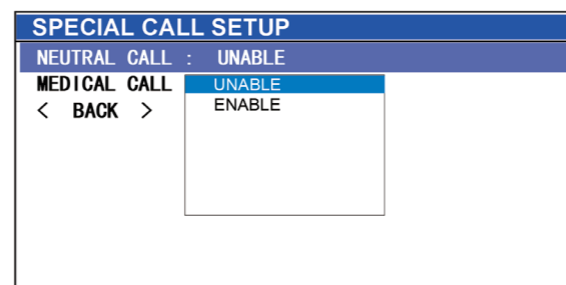

Figure 6.6.6.2

◆ **Memory Reset**

Resetting the memory will erase all user-configured information, including user channel frequencies, contact list entries, and menu settings.

- a: In the main menu, select <CLEAR FLASH> and press [CH/ENT] to open the factory reset dialog.
- b: Turn the channel knob to select <ENTER>, then press [CH/ENT] to erase all user data stored in the memory.
- c: Press [CE] to return to the main menu.

◆ **Self-Test**

- a: In the main menu, select <SELF TEST> and press [CH/ENT] to initiate the automatic system check.
- b: Once the test is complete, press [CE] or [CH/ENT] to return to the main menu.

◆ **Service Information**

Displays the device's serial number and version information

- a: In the main menu, select <SERVICE > and press [CH/ENT] to open the service information dialog.
- b: Press [CE] to return to the main menu.

GNSS Connection

The GNSS interface on the FT-7900 can connect to GNSS receivers with RS232 or RS422 output. The supported GNSS data format includes the following NMEA0183 version 2.0 sentences: RMC, GGA, GLL, ZDA, GNS.

When the device is successfully connected to GNSS and receiving valid GNSS data, the display shows: "— AUTO INPUT". If the GNSS connection is interrupted for 30 seconds, the device will retain the last received GNSS data and display. If the GNSS data is not updated within 4 hours, the device will trigger an audio alert and display a GNSS connection warning dialog, as shown in Figure 7.1.

Press [CE] to close the warning dialog.

If the GNSS data remains unchanged for 23.5 hours, the device will issue another audio alert and display a GNSS connection warning dialog, as shown in Figure 7.2.

Press [CE] to close the warning message.

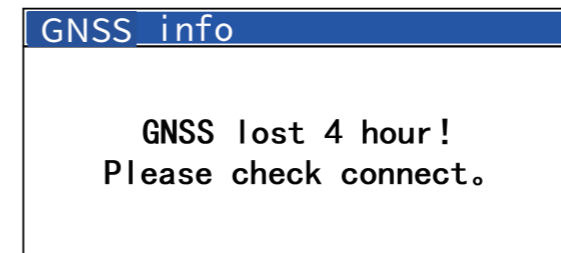

Figure 7.1

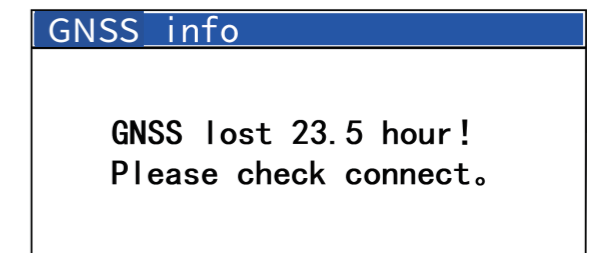
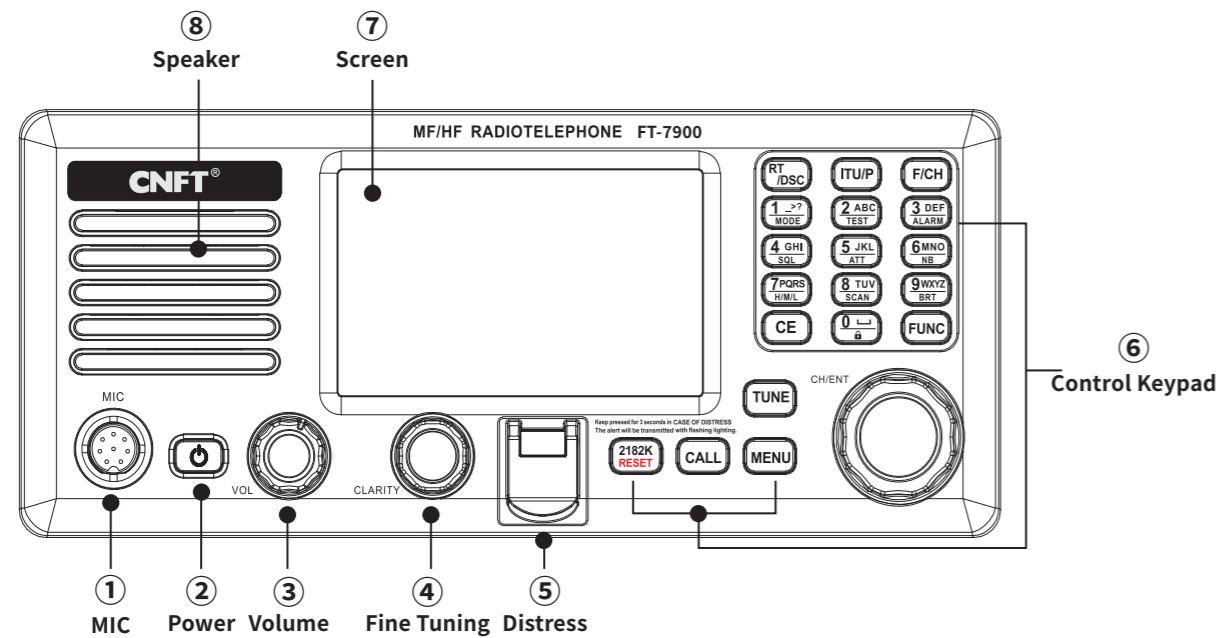

Figure 7.2

Interface Specification

Front View



Rear View

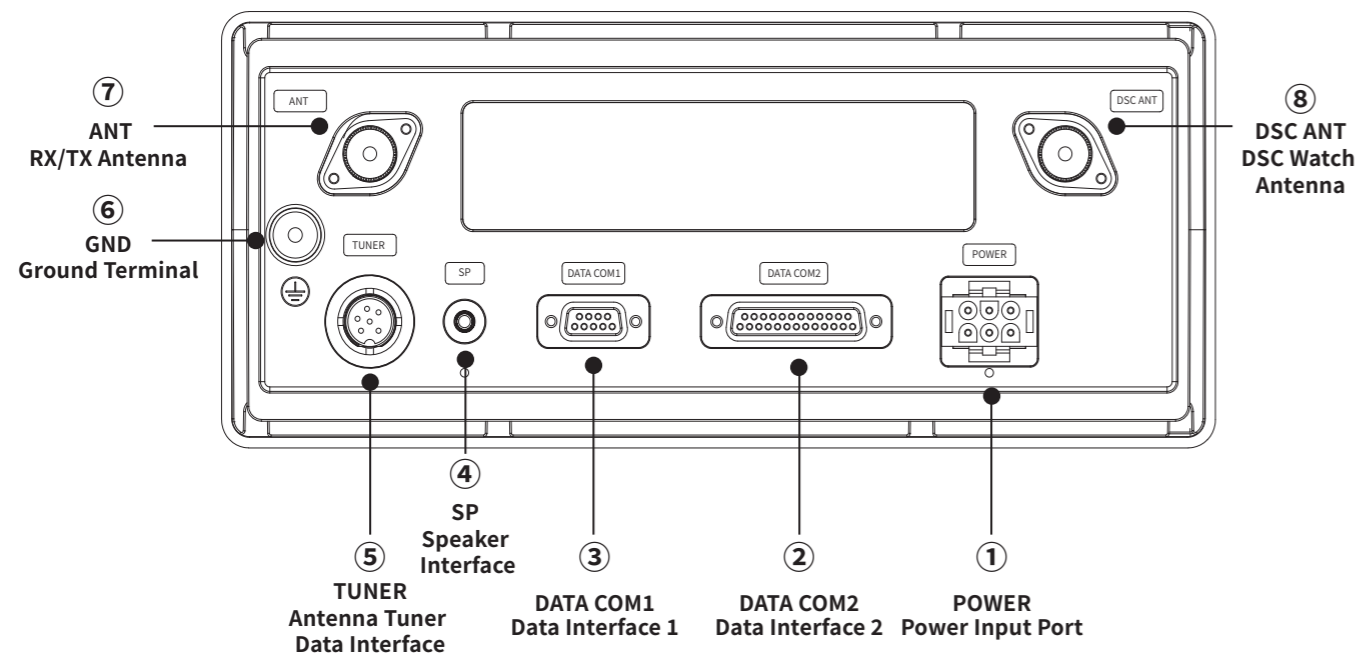

Pin Definition

① POWER(Power Input)

※Note: Rated Input: DC 12V, Operating Range: 10.8V-15.6V, Min Current: 30A

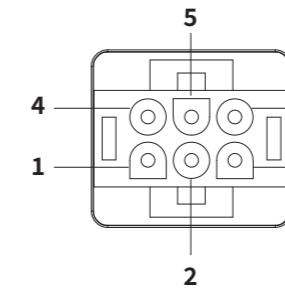

1, 2, 3: Positive terminals (+)

4, 5, 6: Negative terminals (-)

② DATA COM2(Data Interface 2)

※Note: Bidirectional I/O Data Port

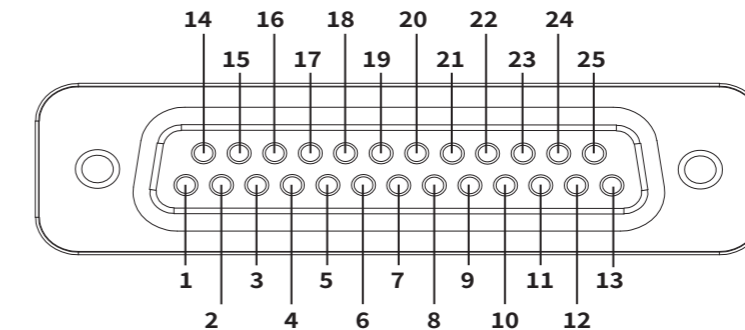

NO.	Pin Definition	Function
1	NC	Reserved
2	NC	Reserved
3	GNSS+	GNSS Position Data Input (+)
4	GNSS-	GNSS Position Data Input (-)
5	EXT_ALARM+	External Alarm Trigger Input (+)
6	EXT_ALARM-	External Alarm Trigger Input (-)

NO.	Pin Definition	Function
7	RS422_RXD+	RS422 Receive Data (+)
8	RS422_RXD-	RS422 Receive Data (-)
9	RS422_TXD-	RS422 Transmit Data (-)
10	RS422_TXD+	RS422 Transmit Data (+)
11	NC	Reserved
12	NC	Reserved
13	NC	Reserved
14	NC	Reserved
15	NC	Reserved
16	NC	Reserved
17	NC	Reserved
18	NC	Reserved
19	NC	Reserved
20	NC	Reserved
21	NC	Reserved
22	12V	12V DC Power Output
23	12V	12V DC Power Output
24	GND	Ground
25	GND	Ground

③ DATA COM1 (Data Interface 1)

※Note: Bidirectional I/O Data Port

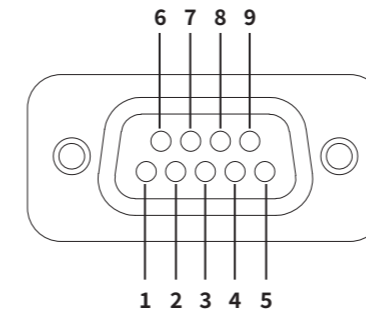

NO.	Definition	Function
1	NC	Reserved
2	RS232_TXD	RS232 Transmit Data
3	RS232_RXD	RS232 Receive Data
4	NC	Reserved
5	GND	Ground
6	B00T1	Boot Signal 1
7	B00T0	Boot Signal 2
8	USB_DM	USB Data Line DM
9	USB_DP	USB Data Line DP

④ SP(3.5mm External Speaker Output Port)

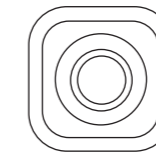

⑤ Antenna Tuner (Tuning Unit Data Connection Interface)

※Note: Interface between main unit and tuner(Optional : FT-600AT, ICOM AT-120/130/140)

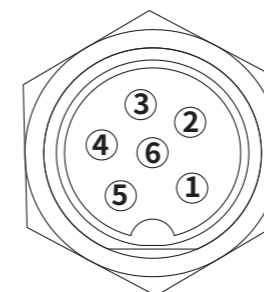

NO.	Definition	Function
1	12V Output	DC 12V
2	GND	Ground
3	START	Tuning Start Command
4	NC	Reserved
5	NC	Reserved
6	OK	Tuning Complete Signal

⑥ GND (System Ground Terminal)

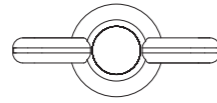

⑦ ANT (RX/TX Antenna Interface)

⑧ DSC ANT (DSC Watch Antenna Interface)

■ Antenna Tuner Connection Instructions

FT-7900 Antenna Tuner Interface Specifications

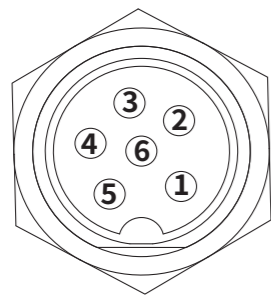

TUNER interface (Port ⑤)

NO.	Definition	Function
1	12V Output	DC 12V
2	GND	Ground
3	START	Tuning Start Command
4	NC	Reserved
5	NC	Reserved
6	OK	Tuning Complete Signal

FT-600AT Antenna Tuner Interface Specifications

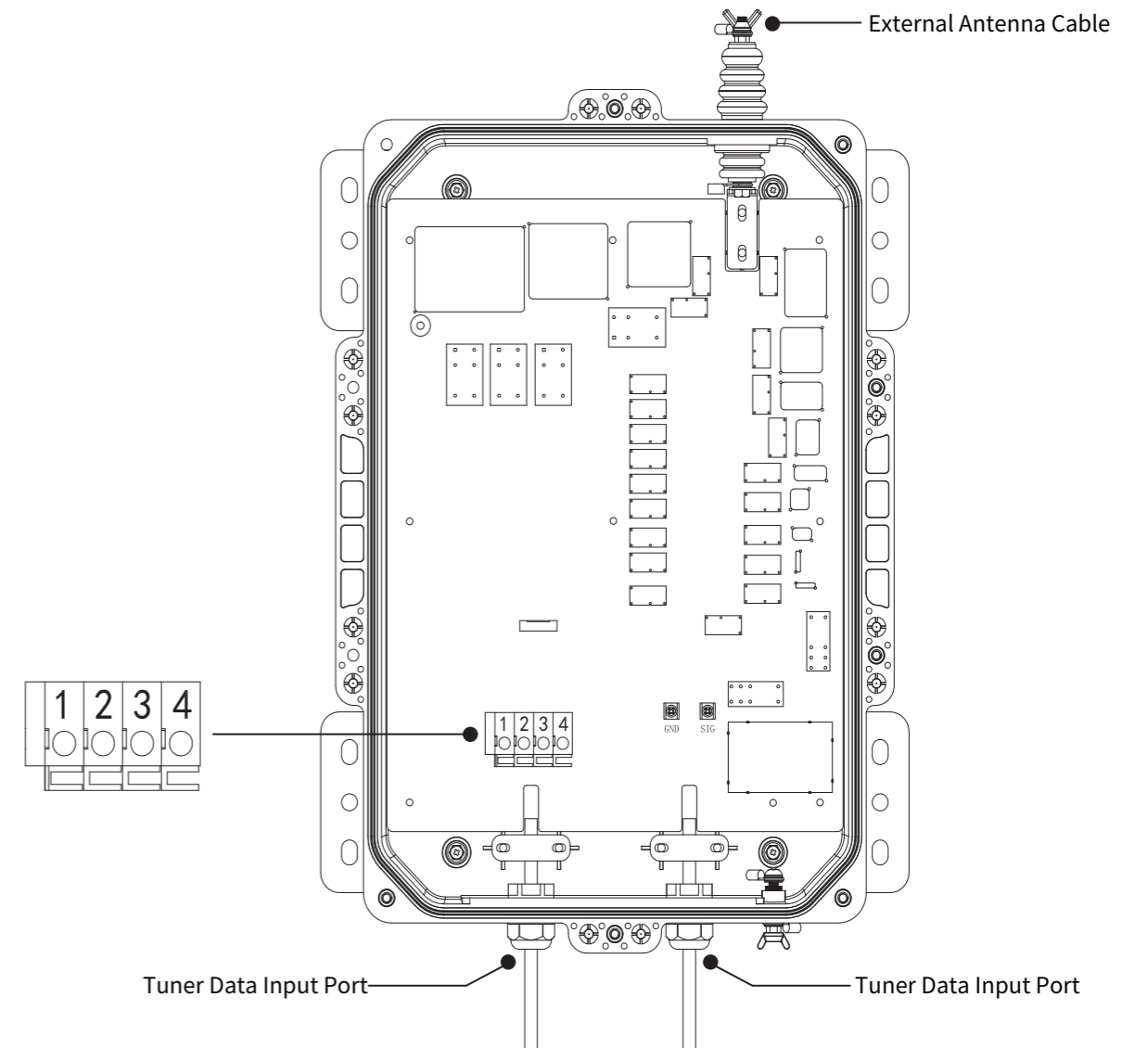

No.	Definition	Function	No.	Definition	Function
1	OK	Tuning Complete Signal	3	GND	Ground
2	START	Tuning Start Command	4	12V Input	DC 12V

FT-500AT Antenna Tuner Interface Specifications

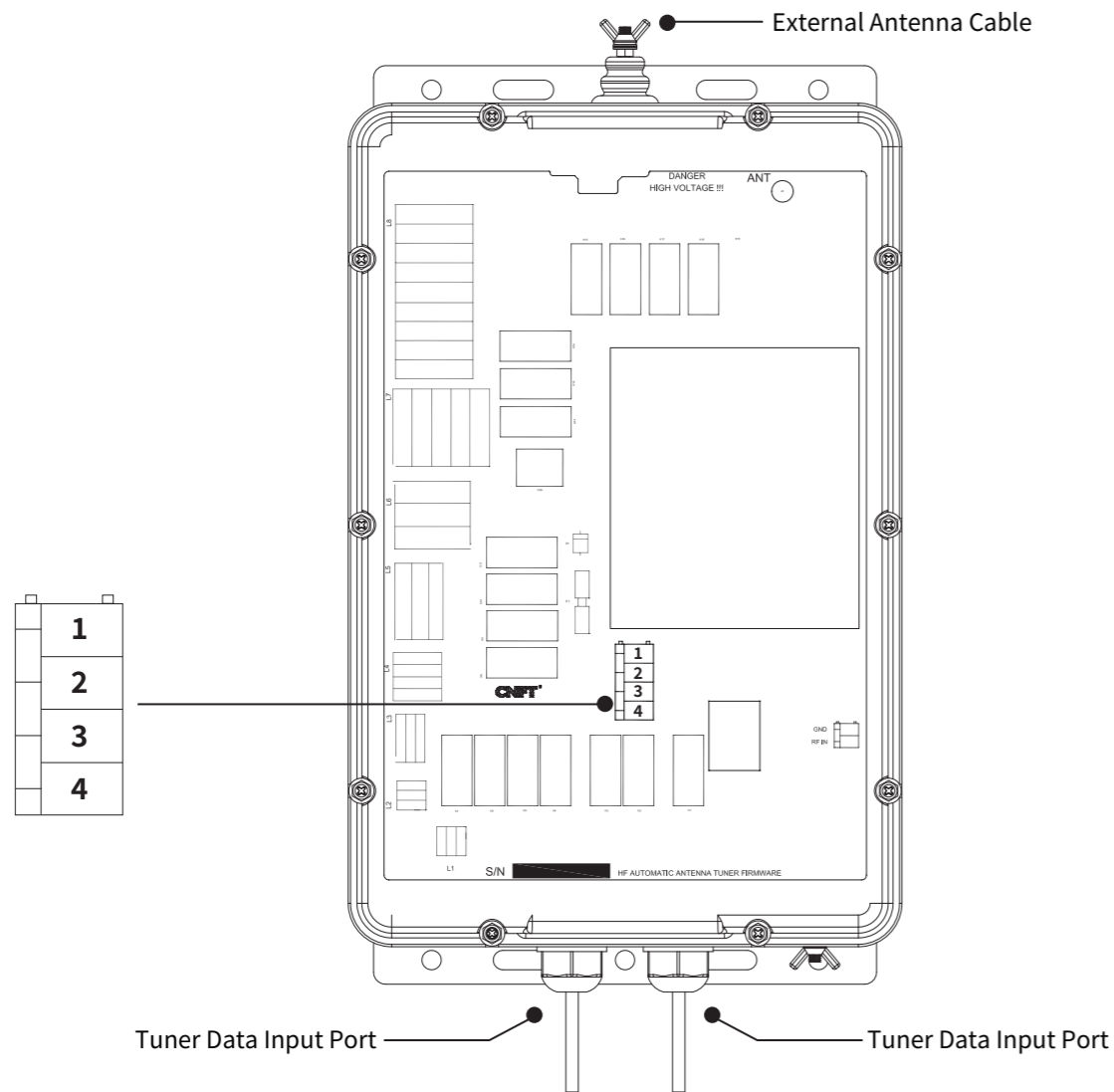

■ FT-7900 Optional Tuner Compatibility

- (1) Compatible with optional ICOM tuners: AT-120, AT-130, and AT-140
- (2) For installation and wiring, refer to the FT-7900 rear panel TUNER interface (Port ⑤) signal output specifications.

No.	Definition	Function	No.	Definition	Function
2	GND	Ground	3	12V Input	DC 12V

Appendix: Frequency Tables

◆ MF – 2MHz SSB Carrier Frequencies

CH NO	Ship Receive(kHz)	Ship Transmit(kHz)	CH NO	Ship Receive(kHz)	Ship Transmit(kHz)
241	1635	2060	271	1725	2069
242	1638	2063	272	1728	2072
243	1641	2066	273	1731	2075
244	1644	2069	274	1734	2078
245	1647	2072	275	1737	2081
246	1650	2075	276	1740	2084
247	1653	2078	277	1743	2087
248	1656	2081	278	1746	2090
249	1659	2084	279	1749	2093
250	1662	2087	280	1752	2096
251	1665	2090	281	1755	2099
252	1668	2093	282	1758	2102
253	1671	2096	283	1761	2105
254	1674	2099	284	1764	2108
255	1677	2102	285	1767	2111
256	1680	2105	286	1770	2114
257	1683	2108	287	1773	2117
258	1686	2111	288	1776	2120
259	1689	2114	289	1779	2123
260	1692	2117	290	1782	2126
261	1695	2120	291	1785	2129
262	1698	2123	292	1788	2132
263	1701	2126	293	1791	2135
264	1704	2129	294	1794	2138
265	1707	2132	295	1797	2060
266	1710	2135			
267	1713	2138			
268	1716	2060			
269	1719	2063			
270	1722	2066			

◆ HF – 4/6MHz SSB Carrier Frequencies

4 MHz SSB (J3E)		
ITU CH NO	Ship RX	Ship TX
401	4357	4065
402	4360	4068
403	4363	4071
404	4366	4074
405	4369	4077
406	4372	4080
407	4375	4083
408	4378	4086
409	4381	4089
410	4384	4092
411	4387	4095
412	4390	4098
413	4393	4101
414	4396	4104
415	4399	4107
416	4402	4110
417	4405	4113
418	4408	4116
419	4411	4119
420	4414	4122
421	4417	4125
422	4420	4128
423	4423	4131
424	4426	4134
425	4429	4137
426	4432	4140
427	4435	4143
428	4351	4351
429	4354	4354
430	4146	4146
431	4149	4149
432(01)	4000	4000
433(02)	4003	4003
434(03)	4006	4006
435(04)	4009	4009
436(05)	4012	4012

4 MHz SSB (J3E)		
ITU CH NO	Ship RX	Ship TX
437(06)	4015	4015
438(07)	4018	4018
439(08)	4021	4021
440(09)	4024	4024
441(10)	4027	4027
442(11)	4030	4030
443(12)	4033	4033
444(13)	4036	4036
445(14)	4039	4039
446(15)	4042	4042
447(16)	4045	4045
448(17)	4048	4048
449(18)	4051	4051
450(19)	4054	4054
451(20)	4057	4057
452(21)	4060	4060

6 MHz SSB (J3E)		
ITU CH NO	Ship RX	Ship TX
601	6501	6200
602	6504	6203
603	6507	6206
604	6510	6209
605	6513	6212
606	6516	6215
607	6519	6218
608	6522	6221
609	6224	6224
610	6227	6227
611	6230	6230

◆ HF – 8MHz SSB Carrier Frequencies

8 MHz SSB (J3E)-Duplex		
ITU CH NO	Ship RX	Ship TX
801	8719	8195
802	8722	8198
803	8725	8201
804	8728	8204
805	8731	8207
806	8734	8210
807	8737	8213
808	8740	8216
809	8743	8219
810	8746	8222
811	8749	8225
812	8752	8228
813	8755	8231
814	8758	8234
815	8761	8237
816	8764	8240
817	8767	8243
818	8770	8246
819	8773	8249
820	8776	8252
821	8779	8255
822	8782	8258
823	8785	8261
824	8788	8264
825	8791	8267
826	8794	8270
827	8797	8273
828	8800	8276
829	8803	8279
830	8806	8282
831	8809	8285
832	8812	8288
833	8291	8291
834	8707	8707
835	8710	8710
836	8713	8713

8 MHz SSB (J3E)-Simplex		
ITU CH NO	Ship RX	Ship TX
837	8716	8716
838	8294	8294
839	8297	8297
840(01)	8101	8101
841(02)	8104	8104
842(03)	8107	8107
843(04)	8110	8110
844(05)	8113	8113
845(06)	8116	8116
846(07)	8119	8119
847(08)	8122	8122
848(09)	8125	8125
849(10)	8128	8128
850(11)	8131	8131
851(12)	8134	8134
852(13)	8137	8137
853(14)	8140	8140
854(15)	8143	8143
855(16)	8146	8146
856(17)	8149	8149
857(18)	8152	8152
858(19)	8155	8155
859(20)	8158	8158
860(21)	8161	8161
861(22)	8164	8164
862(23)	8167	8167
863(24)	8170	8170
864(25)	8173	8173
865(26)	8176	8176
866(27)	8179	8179
867(28)	8182	8182
868(29)	8185	8185
869(30)	8188	8188
870(31)	8191	8191

CH Nos in () are ITU Nos (RR Section C-1)

◆ HF – 12MHz SSB Carrier Frequencies

12 MHz SSB (J3E)		
CH NO.	Ship RX	Ship TX
1201	13077	12230
1202	13080	12233
1203	13083	12236
1204	13086	12239
1205	13089	12242
1206	13092	12245
1207	13095	12248
1208	13098	12251
1209	13101	12254
1210	13104	12257
1211	13107	12260
1212	13110	12263
1213	13113	12266
1214	13116	12269
1215	13119	12272
1216	13122	12275
1217	13125	12278
1218	13128	12281
1219	13131	12284
1220	13134	12287
1221	13137	12290
1222	13140	12293
1223	13143	12296
1224	13146	12299
1225	13149	12302
1226	13152	12305
1227	13155	12308
1228	13158	12311
1229	13161	12314
1230	13164	12317
1231	13167	12320
1232	13170	12323
1333	13173	12326
1234	13176	12329
1235	13179	12332

12 MHz SSB (J3E)		
CH NO.	Ship RX	Ship TX
1236	13182	12335
1237	13185	12338
1238	13188	12341
1239	13191	12344
1240	13194	12347
1241	13197	12350
1242	12353	12353
1243	12356	12356
1244	12359	12359
1245	12362	12362
1246	12365	12365

◆ HF – 16MHz SSB Carrier Frequencies

16 MHz SSB (J3E)		
CH NO.	Ship RX	Ship TX
1601	17242	16360
1602	17245	16363
1603	17248	16366
1604	17251	16369
1605	17254	16372
1606	17257	16375
1607	17260	16378
1608	17263	16381
1609	17266	16384
1610	17269	16387
1611	17272	19390
1612	17275	16393
1613	17278	16396
1614	17281	16399
1615	17284	16402
1616	17287	16405
1617	17290	16408
1618	17293	16411
1619	17296	16414
1620	17299	16417
1621	17302	16420
1622	17305	16423
1623	17308	16426
1624	17311	16429
1625	17314	16432
1626	17317	16435
1627	17320	16438
1628	17323	16441
1629	17326	16444
1630	17329	16447
1631	17332	16450
1632	17335	16453
1633	17338	16456
1634	17341	16459
1635	17344	16462

16 MHz SSB (J3E)		
CH NO.	Ship RX	Ship TX
1636	17347	16465
1637	17350	16468
1638	17353	16471
1639	17356	16474
1640	17359	16477
1641	17362	16480
1642	17365	16483
1643	17368	16486
1644	17371	16489
1645	17374	16492
1646	17377	16495
1647	17380	16498
1648	17383	16501
1649	17386	16504
1650	17389	16507
1651	17392	16510
1652	17395	16513
1653	17398	16516
1654	17401	16519
1655	17404	16522
1656	17407	16525
1657	16528	16528
1658	16531	16531
1659	16534	16534
1660	16537	16537
1661	16540	16540
1662	16543	16543
1663	16546	16546

◆ HF – 18/19MHz SSB Carrier Frequencies ◆ HF – 25/26MHz SSB Carrier Frequencies

18/19 MHz SSB (J3E)		
CH NO.	Ship RX	Ship TX
1801	19755	18780
1802	19758	18783
1803	19761	18786
1804	19764	18789
1805	19767	18792
1806	19770	18795
1807	19773	18798
1808	19776	18801
1809	19779	18804
1810	19782	18807
1811	19785	18810
1812	19788	18813
1813	19791	18816
1814	19794	18819
1815	19797	18822
1816	18825	18825
1817	18828	18828
1818	18831	18831
1819	18834	18834
1820	18837	18837
1821	18840	18840
1822	18843	18843

25/26 MHz SSB (J3E)		
CH NO.	Ship RX	Ship TX
2501	26145	25070
2502	26148	25073
2503	26151	25076
2504	26154	25079
2505	26157	25082
2506	26160	25085
2507	26163	25088
2508	26166	25091
2509	26169	25094
2510	26172	25097
2511	25100	25100
2512	25103	25103
2513	25106	25106
2514	25109	25109
2515	25112	25112
2516	25115	25115
2517	25118	25118

◆ HF – 22MHz SSB Carrier Frequencies

22 MHz SSB (J3E)		
CH NO.	Ship RX	Ship TX
2201	22696	22000
2202	22699	22003
2203	22702	22006
2204	22705	22009
2205	22708	22012
2206	22711	22015
2207	22714	22018
2208	22717	22021
2209	22720	22024
2210	22723	22027
2211	22726	22030
2212	22729	22033
2213	22732	22036
2214	22735	22039
2215	22738	22042
2216	22741	22045
2217	22744	22048
2218	22747	22051
2219	22750	22054
2220	22753	22057
2221	22756	22060
2222	22759	22063
2223	22762	22066
2224	22765	22069
2225	22768	22072
2226	22771	22075
2227	22774	22078
2228	22777	22081
2229	22780	22084
2230	22783	22087

22 MHz SSB (J3E)		
CH NO.	Ship RX	Ship TX
2231	22786	22090
2232	22789	22093
2233	22792	22096
2234	22795	22099
2235	22798	22102
2236	22801	22105
2237	22804	22108
2238	22807	22111
2239	22810	22114
2240	22813	22117
2241	22816	22120
2242	22819	22123
2243	22822	22126
2244	22825	22129
2245	22828	22132
2246	22831	22135
2247	22834	22138
2248	22837	22141
2249	22840	22144
2250	22843	22147
2251	22846	22150
2252	22849	22153
2253	22852	22156
2254	22159	22159
2255	22162	22162
2256	22165	22165
2257	22168	22168
2258	22171	22171
2259	22174	22174
2260	22177	22177

Maintenance

◆ Troubleshooting

Symptoms	Possible Causes	Troubleshooting
Unable to power on	Power reversed; power cable not securely connected; equipment input voltage over the limit	Check the power connection direction and reconnect properly; Secure the power cable; Ensure the equipment input voltage is within the operating voltage range
Insufficient transmission power	Antenna improperly installed, such as loose connections or angle deviation; obstructions nearby affecting signal	Reinstall the antenna, ensuring it is stable and at the correct angle; remove any obstructions around the antenna
Weak or no received signal	Antenna not correctly connected; antenna entangled with foreign objects	Inspect the antenna connection points and reconnect properly; clear any foreign objects around the antenna
High communication noise	Equipment not grounded; Interface source nearby, such as other electrical devices;	Properly ground the equipment; Keep the equipment away from interface sources

◆ Regular Inspections

To maintain optimal performance of the device, please regularly perform the following essential inspections.

Item	Phenomenon	Action
Power Cable	Exposed, Damaged	Replace
Power Plug	Loose	Plug in Securely
Display Components	Corroded	Clean
Supply Voltage	Overvoltage, Undervoltage	Check the Power Supply

◆ Cleaning

Dust and stains on the surface of the device can be wiped off with a soft cloth. If necessary a dampened soft cloth can also be used for cleaning. Please take special care when wiping the LCD screen, as it is easily scratched. Do not use chemical cleaners, as they may remove the paint or markings on the instrument's surface.

安全提示

⚠ 危险!

- 发射期间, 请勿触摸天线耦合器的同轴电缆。
- 发射期间触摸电缆可能会导致触电、重伤或死亡。
- 请勿触摸天线。
- 发射期间触摸天线可能会导致触电、重伤或死亡。

⚠ 警告!

- 除非完全熟悉电气电路, 否则请勿在设备内部作业。
- 设备内部存在可能导致触电的危险电压。

- 开始安装前, 请关闭主配电板上的电源。在开关附近张贴标志, 表明设备安装期间不应打开电源。如果设备安装期间电源未关闭或接通, 可能会导致火灾、触电或重伤。

⚠ 注意!

- 确认电源电压与设备的额定电压兼容。连接错误的电源可能会导致火灾或设备损坏额定电压显示在显示单元背面的标签上。
- 小心使用接地铜带其边缘可能会伤到您的手。
- 请保持以下罗盘安全距离70MM以上。
- 接地设备: 未接地的设备可能会发出或收电磁干扰, 或导致触电。

目录

安全提示.....	63	遇险报警呼叫操作.....	80-84
前言.....	66-67	■ 遇险报警呼叫操作	80
主要技术指标.....	66	◆ 发送遇险报警呼叫	80
安装说明.....	68-73	◆ 接收遇险报警应答呼叫	81
■ 电气安装.....	68	◆ 接收遇险报警呼叫	81
■ 固定安装.....	69	■ 遇险报警转发呼叫	82
■ 天调安装.....	72	◆ 将遇险报警转发到某个海域	82
■ 天线安装.....	73	◆ 接收转发到海域的遇险报警呼叫	82
面板说明.....	74-77	◆ 将遇险报警转发到某个单台	83
■ 显示界面.....	74	◆ 接收转发到单台的遇险报警应答呼叫.....	84
■ 前面板布局.....	75	◆ 接收转发到单台的遇险报警呼叫	84
基本操作.....	78-79	普通呼叫操作.....	85-96
■ 如何开关机	78	■ 单台呼叫	85
■ 如何转换频道	78	◆ 发送单台呼叫	85
■ 如何输入频率	78	◆ 接收单台应答呼叫	85
■ 如何调谐ATU	78	◆ 接收单台呼叫	86
■ 如何切换信号类型.....	78	■ 海域呼叫	86
■ 如何快速发送DSC测试呼叫.....	78	◆ 发送海域呼叫	86
■ 如何开启报警.....	78	◆ 接收海域呼叫	87
■ 如何打开静噪功能.....	78	■ 群组呼叫	88
■ 如何打开信号衰减功能.....	79	◆ 发送群组呼叫	88
■ 如何打开消噪功能.....	79	◆ 接收群组呼叫	89
■ 如何设置发射功率.....	79	■ 电话呼叫	89
■ 如何开启扫描.....	79	◆ 发送电话呼叫	89
■ 如何调整背光亮度.....	79	◆ 接收电话应答呼叫	90
■ 如何标记频道.....	79	◆ 接收电话呼叫	91
■ 如何开启DSC日常通道扫描.....	79	■ 位置请求呼叫	91

◆ 发送位置请求呼叫	91	◆ 应答设置	105
◆ 接收位置请求应答呼叫	92	◆ 打印设置	106
◆ 接收位置请求呼叫	92	◆ 频率转换设置	106
■ 测试呼叫	93	◆ 特殊呼叫设置	107
◆ 发送测试呼叫	93	■ 清空储存器	107
◆ 接收测试应答呼叫	93	■ 自检测试	107
◆ 接收测试呼叫	94	■ 服务信息	107
■ 中立船呼叫	95	GNSS连接	108
■ 医疗船呼叫	95	系统接口规格说明	109-116
■ 查询呼叫	96	频率表	117-124
菜单操作	97-107	设备更新与维护	125
■ 如何使用菜单	97		
■ 通讯录	97		
■ 呼叫文件	98		
■ 呼叫日志	99		
■ 系统设置	99		
◆ 本地时间设置	99		
◆ 时差设置	100		
◆ 超时设置	100		
◆ 扬声器设置	101		
◆ 语言设置	101		
◆ 声音设置	102		
◆ 天调设置	102		
◆ 功率设置(仅韩国地区版本可用)	103		
◆ 通信速率设置	103		
◆ 显示模式设置	104		
■ 数字选呼设置	104		
◆ 本机MMSI设置	104		
◆ 位置设置	105		

前言

感谢您选用本公司研制的产品,型号:FT-7900 名称:船载中高频(MF/HF)DSC无线电装置。产品包括主机以及随机配置附件,请参看产品《装箱清单表》。在安装使用产品前,请务必仔细阅读《操作手册》,避免人员不专业、错误操作引起设备损坏或人身安全,本公司不承担由此引起的一切后果责任。
※注:若产品升级更新导致《操作说明》与设备实际操作使用不一致,请以设备为准。

主要技术指标

设备采用12V直流电源供电,电源输出电流不小于45A

(1)温度范围: -15°C ~ +55°C

(2)相对湿度: 0~95%

项目名称	技术参数	
综合指标	频率范围	发射频率1.6MHz~27.5MHz; 接收频率0.5MHz~29.9999MHz
	输出功率	≤150W
	频率误差	±10Hz(1605kHz~27500kHz)
	频道数量	≥400
	工作模式	无线电话: J3E (USB,LSB), H3E (AM); DSC: F1B(FSK)
	罗经安全距离	70cm
	显示器/尺寸	5寸全彩液晶/160(H)×300(W)×300(D)mm
	接口	RS-232, RS-422
	净重量	7600g
	工作温度	-15° ~ 55°C
发射部分	防护等级	收发单元IP22; 天调IP66
	频率误差	≤±10Hz(1605kHz~27500kHz)
	调频残余	≤±5Hz
	互调分量	≤-25dB
	麦克风灵敏度	-9dB≤Δ(信号变化)≤-3dB(1000Hz、94dBA)
	残余交流声	≤40dB
	噪声功率	≤40dB
	寄生频率调制	≥-26dB
	载波抑制	≥40dB
传导杂散发射	9kHz至2GHz ≤43dB、2GHz至4GHz ≤43dB	

项目名称	技术参数		
发射部分	频率误差	≤±10Hz	
	调频残余	≤±5Hz	
	音频通带	350Hz~2700Hz	
接收机	最大可用灵敏度	1605kHz-4000kHz: J3ED≥+16dBuV、H3E≥+30dBuV F1B(数字输出)≥+5dBuV、F1B(模拟输出)≥+10dBuV 4MHz-27.5MHz: J3E≥+11dBuV F1B(数字输出)≥+0dBuV、F1B(模拟输出)≥+5dBuV	
	相邻信道选择性	-1kHz和+4kHz ≥ 40dB -2kHz和+5kHz ≥ 50dB -5kHz和+8kHz ≥ 60dB	
	阻塞	≥ +65dB	
	交调	≥ +90dBu	
	互调	≥ +80dBuV	
	杂散响应抑制比	≥60dB	
	音频互调	≤-25dB	
	总失真系数	≤5%	
	内部产生的杂波信号	J3E: ≥10dB	
	传导杂波辐射	9kHz~2GHz: ≤2nW(-57dBm)、2GHz~4GHz: ≤20nW(-37dBm)	
	AGC提高的信噪比	J3E: ≥15dB	
	AGC范围	≤10dB	
	音频输出电平	≥2W	
	AGC时间常数	启动时间: 5ms-10ms、恢复时间: 1s-4s	
	相互混频	J3E: ≥+100dBuV	
	DSC	频率误差	≤±10Hz(1615Hz和1785Hz)
		呼叫灵敏度	1uV, 误码率≤10 ⁻²
		标称调制率	100bit/s(50Hz)
剩余调制		≤-26dB	
相邻信道选择性		-1kHz和+4kHz ≥ 45dB、-2kHz和+5kHz ≥ 50dB -5kHz和+8kHz ≥ 60dB	
交调		≥ +90dBu	
互调		≥ +80dBuV	
音频互调		≤-25dB	

安装说明

■ 电气安装

设备使用前,一定要正确的连接电源,天线以及需要连接的外部设备。
设备需要连接电压为12V,输出电流不小于45A的DC电源。

系统连接图说明

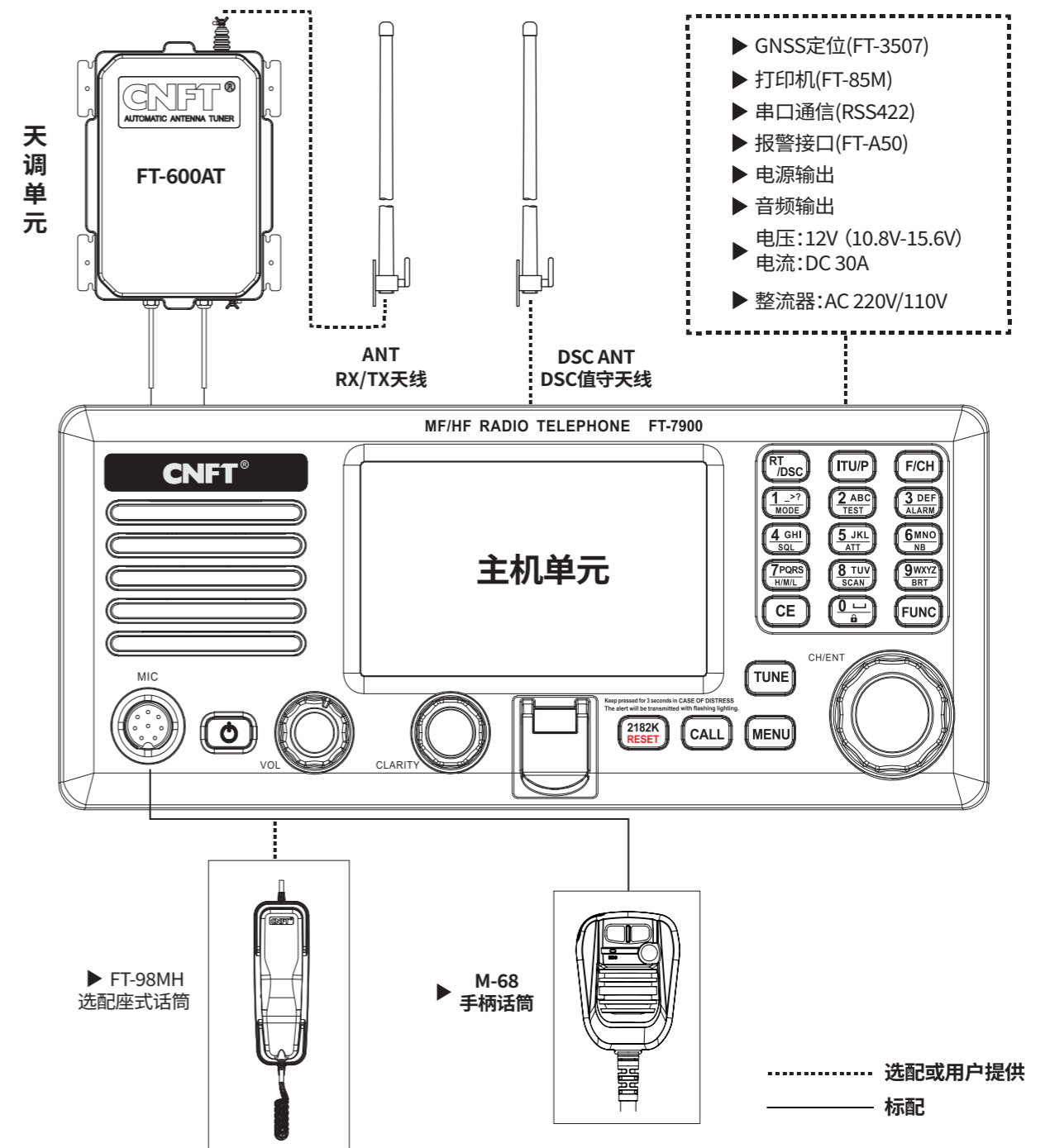

■ 固定安装

- ※ 产品应该安装在远离发动机并通风良好的地方。
- ※ 不要安装在阳光直射的地方。
- ※ 不要把产品放在距离罗经 1 米之内。

1:产品配有一个可以翻转的安装支架。支架用5枚螺丝固定。

2:在安装之前,保证在支架后面有100mm的垂直空隙和70mm的水平空隙,以便对产品进行调整。

3:产品的倾斜角度可以通过夹钳进行调整。

主机支架类型

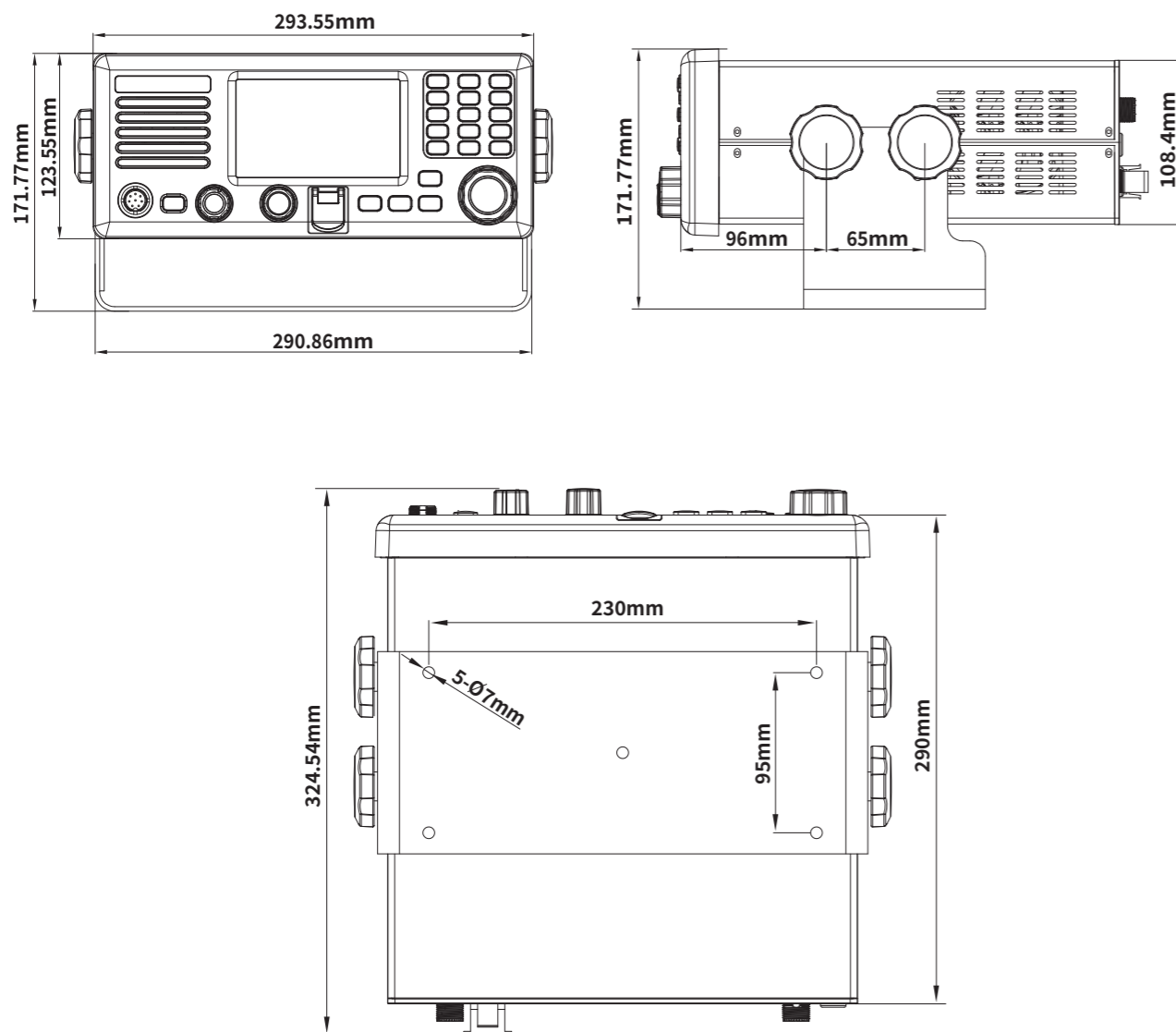

主机支架吊顶类型

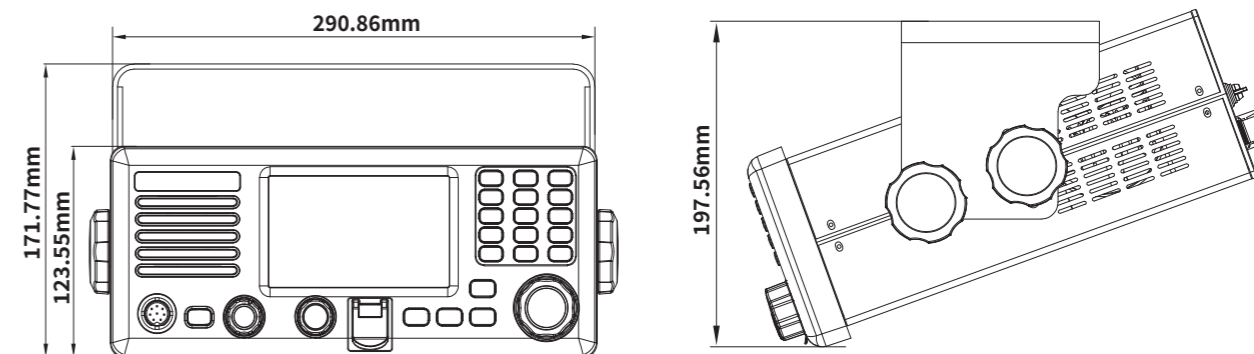

天调单元支架类型

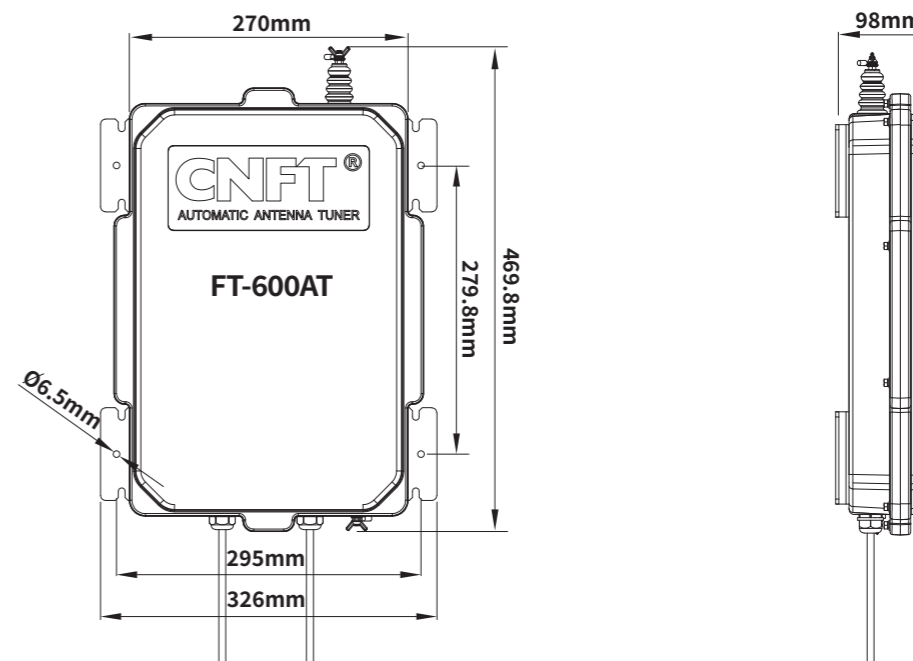

■ 天线安装

天线安装示意图

天线安装十分重要,合理的架设可减少干扰,使通讯距离达到最佳,安装时请注意如下几点:

- ① 天线应架设在垂直位置上,在水平面上应尽可能远离导电物体,最小距离不低于0.5米,天线不能靠近大型的垂直物体,并保证360°无阻挡。
- ② 天线应尽量远离大功率发射源,如雷达、电台或其他无线电天线,最好离开3米以上。
- ③ 两副天线不能在同一平面内,如在同一平面内两副天线间距应在10米以上,条件不允许可将两副天线安装成上下垂直,且高度差应超过2.5米以上。
- ④ 室外电缆接口要防水处理。
- ⑤ 天线电缆长度应尽量短,并要远离电源电缆,如果与电缆交叉应保持90°垂直。
- ⑥ 如安装在灯杆上应用绝缘物体隔离,并在高度上超过1.5米以上。

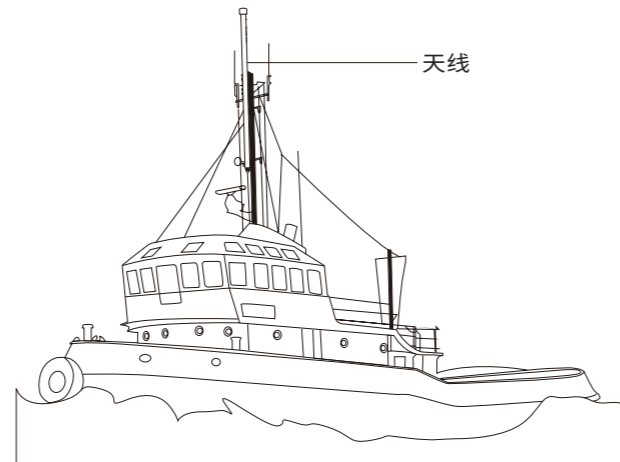

鞭状天线安装示意图

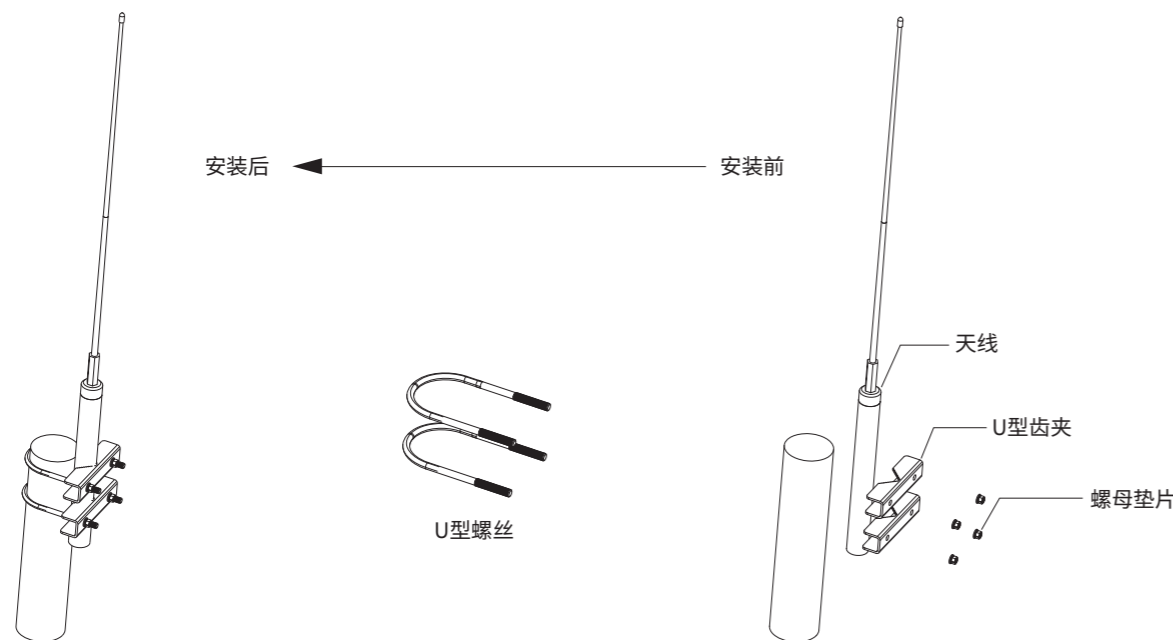

面板说明

■ 显示界面

显示界面操作说明

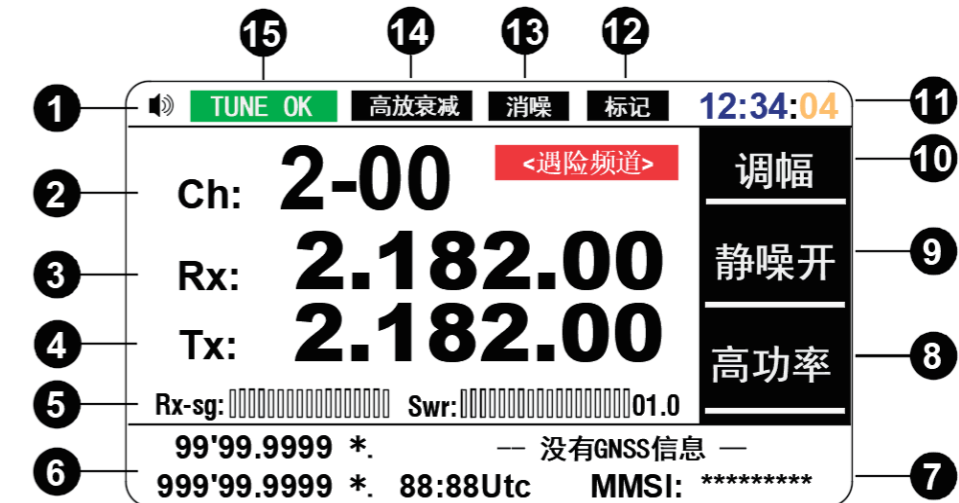

- ① 扬声器状态
- ② 频道属性及频道号
- ③ 接收频率
- ④ 发射频率
- ⑤ 接收信号强度指示 & 发射信号功率指示, 天线驻波比SWR显示
- ⑥ GNSS信息
- ⑦ 本机的MMSI号码
- ⑧ 设定功率标识
- ⑨ 静噪功率标识
- ⑩ 信号种类标识
- ⑪ 本地时间
- ⑫ 当前频道被标记/记忆(标记)标识
- ⑬ 噪声抑制(消噪)功能标识
- ⑭ 信号衰减(高放衰减或中放衰减)功能标识
- ⑮ 天线调谐器(ATU)状态

■ 前面板布局

键盘操作说明

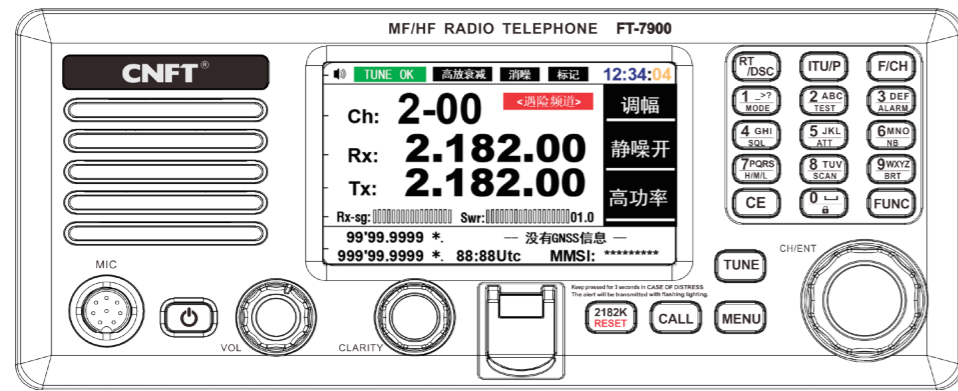

MIC	麦克风插座
Power	正确接通设备的电源后, 长按3秒钟开机或者关机
VOLUME	调整音量输出水平, 右旋增大音量, 左旋减小音量 (旋钮)
CLARITY	在接收频率上 ± 10Hz 调整, 可以清晰接收频率偏移的信号 (旋钮)
DISTRESS	打开红色保护盖, 然后长按此按钮5秒, 设备将发送遇险求救呼叫
2182K	按下时在2182K->4125K->6215K->8291K->12290K->16420KHz 循环选择
CALI	打开呼叫列表菜单, 编辑要发送/保存的呼叫
TUNE	天线调谐开关, 仅当设备连接了ATU单元时激活
MENU	打开系统主菜单
LOG	打开DSC呼叫日志文件

CH/ENT	旋转时在主界面改变光标位置频道、频率, 其他界面改变改变光标; 按下为【确认】功能键 (旋钮)
RT/DSC	在DSC扫描接收界面和RT主界面之间切换
ITU/P	选择频用户组组和ITU海事频道组
F/CH	主界面下选择编辑光标的位置, CH频道号->RX频率-TX频率 可在对应的光标处使用数字键编辑频道号或者频率
CE	取消当前操作, 返回上一级菜单
FUNC	数字键复用功能开启, 当按下时显示器显示“功能键”标识, 再按某数字键即开启该数字键的复用功能
1->? MODE	默认功能<数字1>, 复用功能<MODE>。复用功能: 切换信号类型: 上边带->下边带->调幅->窄带R
2 ABC TEST	默认功能<数字2>, 复用功能<TEST>; 复用功能: 打开DSC测试呼叫编辑界面。*仅DSC设备可激活该功能
3 DEF ALARM	默认功能<数字3>, 复用功能<ALARM> 复用功能: 在2182KHz频率上, 设备自动交替发送2200Hz和1300Hz的紧急音频信号。仅当遇险时使用
4 GHI SQL	默认功能<数字4>, 复用功能<SQL> 复用功能: 静噪开关。打开静噪时, 显示器显示“静噪开”, 这时在未接收到信号时, 接收机会排除不需要的背景噪音。关闭静噪时, 显示器显示“静噪关”
5 JKL ATT	默认功能<数字5>, 复用功能<ATT> 复用功能: 当接收机的信号电平过大导致信号失真时, 可开启改功能, 在高频放大处或者中频放大处衰减接收机的信号, 以达到消除失真的目的。该功能开启时, 显示器上会显示“高放衰减”标识或者“中放衰减”标识
6 MNO NB	默认功能<数字6>, 复用功能<NB>。 复用功能: 打开噪声抑制功能, 以去除脉冲类型的噪音, 如发送机点火的噪音 该功能开启时, 显示器上会显示“消噪”标识
7 PQR H/M/L	默认功能<数字7>, 复用功能<H/M/L>。复用功能: 切换发射机输出功率, 高功率->中功率->低功率
8 TUV SCAN	默认功能<数字8>, 复用功能<SCAN>。复用功能: 打开扫描界面, 3.12节
9 WXYZ BRT	默认功能<数字9>, 复用功能<BRT>。复用功能: 打开背景灯亮度调节对话框, 3.13节
0 Lock	默认功能<数字0>, 复用功能<键盘锁>。复用功能: 锁定按键/旋钮操作。该功能开启后, 显示器上会显示“锁定”标识图标 (键盘锁定提示框) 此时操作按键和旋钮均无响应。可再单独按此键解除锁定, “标识”标识图标 (提示框) 消失。*键盘被锁定期间, 允许【2182K】和【DISTRESS】键响应, 用于应急操作
LCD	5寸TFT显示器

主机单元前视图说明

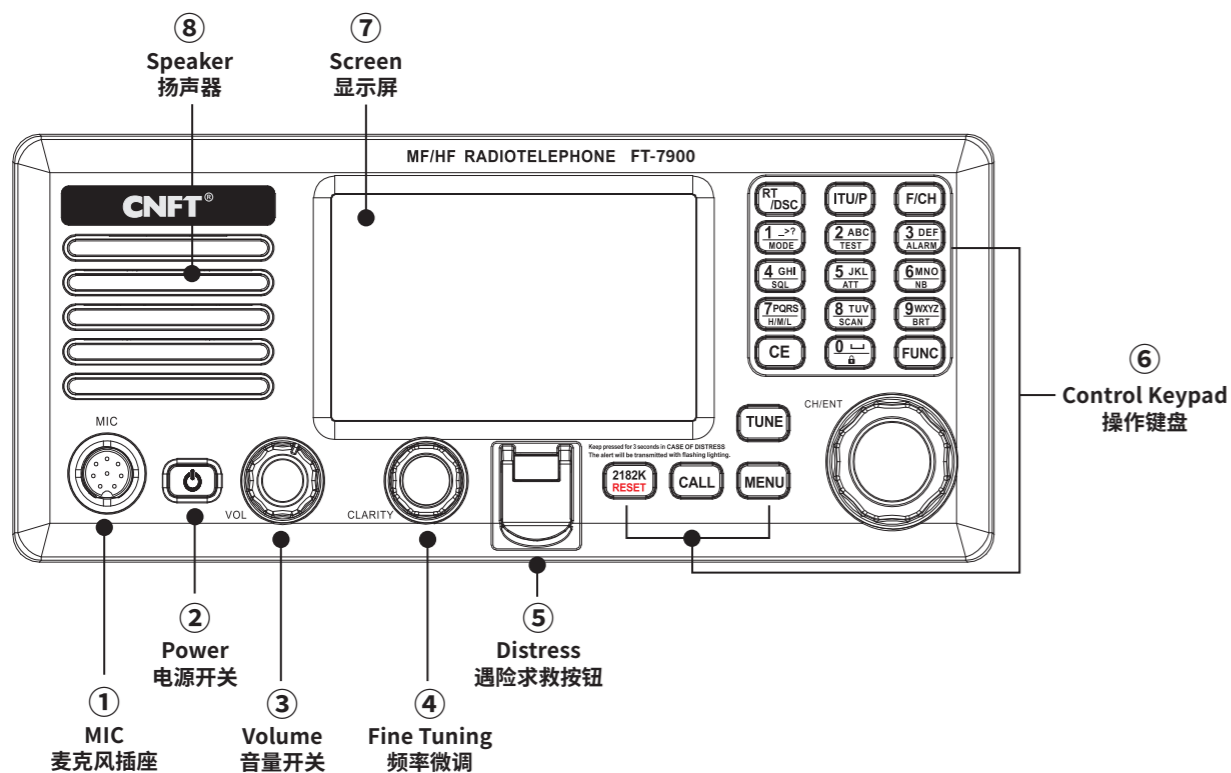

主机单元后视图说明

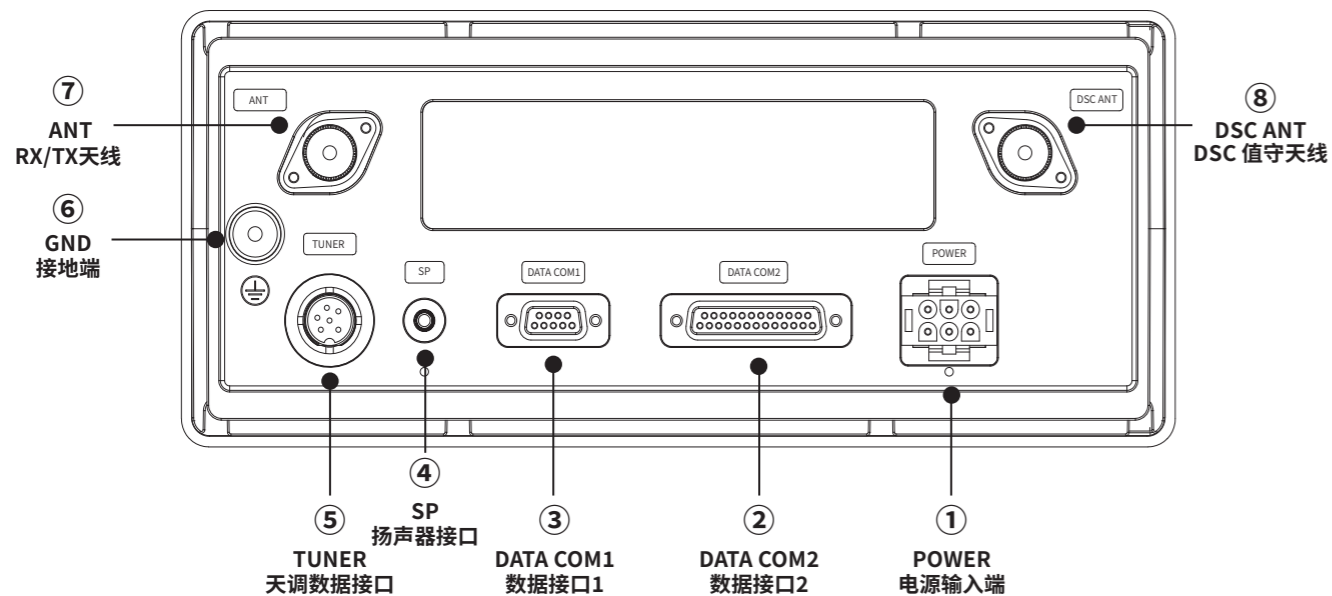

基本操作

◆ 如何开关机

在设备已经正确连接了电源后，长按 [电源] 键3秒钟开机/关机。

◆ 如何转换频道

FT-7900有两种频道模式。

一、用户频道模式，二、ITU国际频道模式；

在待机主界面下，按面板上的 [频道] 键切换频道模式，然后旋转 [CH/ENT] 旋钮转换频道，或者直接按 [0] ~ [9] 键输入频道号后按 [确认] 键确认；用户私有频道总数200个，即CH1~CH200。

◆ 如何输入频率

在用户频道模式下，按面板上的 [频率] 键，选择要编辑的内容(包括CH频道号，RX接收频率，TX发射频率)，按 [数字] 键输入相应内容，完毕后按 [确认] 键或者 [频率] 键确认。按 [取消] 键可清空输入。

※在ITU国际频道模式下，频率不可更改。

◆ 如何调谐ATU

按面板上的 [调谐] 键开始调谐ATU，待调谐完成后，主界面会提示“TUNE OK”。

※菜单中如果将天调类型设置为宽带天线，那么就不用调谐。

◆ 如何切换信号类型

在主界面下，先按 [功能] 键，这时显示器右侧会显示”功能键”图标，再按 [1/模式] 键切换信号类型:上边带->下边带->调幅->窄带R。

◆ 如何快速发送DSC测试呼叫

在主界面下，先按 [功能] 键，这时显示器右侧会显示”功能键”图标，再按 [2/测试] 键，打开呼叫编辑界面，详细操作请参阅本手册第5.6节。

◆ 如何开启报警

为了兼容老版本的单边带电台的报警模式，FT-7900具有报警功能。在主界面下，先按 [功能] 键，这时显示器右侧会显示“功能键”图标，再按 [3/报警] 键，设备将在2.182MHZ频率上，使用H3E信号发出报警。报警频率为1300HZ和2200HZ。按 [取消] 键关闭报警。

◆ 如何打开静噪功能

在主界面下，先按 [功能] 键，这时显示器右侧会显示”功能键”图标，再按 [4/静噪] 键，关闭/打开静噪功能。

◆ 如何打开信号衰减功能

在主界面下，先按 **[功能]** 键，这时显示器右侧会显示“功能键”图标，再按 **[5/衰减]** 键循环选择高放衰减或者中放衰减，这时显示器会显示“高放衰减”或者“中放衰减”。

◆ 如何打开消噪功能

在主界面下，先按 **[功能]** 键，这时显示器右侧会显示“功能键”图标，再按 **[6/消噪]** 键打开ATT功能，这时显示器会显示“消噪”。

◆ 如何设置发射功率

在主界面下，先按 **[功能]** 键，这时显示器右侧会显示“功能键”图标，再按 **[7/功率]** 键，切换发射功率。

◆ 如何开启扫描

在主界面下，先按 **[功能]** 键，这时显示器右侧会显示“功能键”图标，再按 **[8/扫描]** 键，打开扫描功能界面。旋转 **[CH/ENT]** 旋钮，选择扫描类型，扫描速度，然后选择**<开始>**项，设备将开始扫描。在静噪功能开启并且是频道扫描的状态下，如果接收到有效信号，那么FT-7900将停止扫描监听该信号，待信号消失3秒钟后继续扫描。

◆ 如何调整背光亮度

在主界面下，先按 **[功能]** 键，这时显示器右侧会显示“功能键”图标，再按 **[9/亮度]** 键，打开调节背光对话框，旋转 **[CH/ENT]** 旋钮选择需要的显示器背光等级，旋转 **[CLARITY]** 旋钮选择需要的按键背光等级。按 **[取消]** 键关闭对话框。

◆ 如何标记频道

在主界面下，按 **[确认]** 键标记当前频道，这时显示器会显示“标记”图标，被标记的频道用于频道扫描。

如果当前频道已经被标记，那么该操作将取消标记。

◆ 如何开启DSC日常通道扫描

普通呼叫可使用主机的接收机进行6个频率的扫描。

a:按面板上的 **[RT/DSC]** 键打开扫描界面，这时主机接收通道开始扫描，DSC日常通道扫描可以设置6个接收频率；

b:按 **[功能]** 键，停止DSC日常通道扫描，DSC紧急通道禁止停止；

c:按 **[确认]** 键，打开频率列表，使用频道旋钮选择要设置的频率，然后按 **[确认]** 键确认；

d:按 **[功能]** 键，继续扫描；

按 **[取消]** 键退出。

遇险报警呼叫操作

※DSC的操作须在设备有正确的MMSI号码后才可以进行，如果没有有效的MMSI号码，那么按面板上的 **[DISTRESS]** 键和 **[呼叫]** 键时，会弹出没有MMSI号码警告提示框。以下操作默认为设备已经设置了有效的MMSI号码以及正确连接了GNSS设备。

◆ 遇险报警呼叫

◇ 发送遇险报警呼叫

a:首先按面板上的 **[DISTRESS]** 键，打开发送遇险报警呼叫操作界面，如图4.1.1所示。

遇险报警	
呼叫目标：	所有船
遇险船：	888888888
遇险种类：	未指明种类
通信频率：	无线电 / 8291.0KHz
遇险位置：	99°99 . 9999 *. 999°99 . 9999 *. 88:88 Utc
发送频率：	8414.5kHz
请长按遇险键5秒钟发送遇险呼叫！	

图4.1.1

b:按 **[确认]** 键打开遇险种类列表，使用频道旋钮选择遇险的种类。遇险的种类包括：火灾、进水、碰撞、搁浅、倾斜、沉没、失控、未指明种类、弃船、海盗、有人落水共11种。默认为：未指明种类，按 **[确认]** 键确认。

c:设备允许操作者手动输入GNSS信息，旋转频道旋钮将光标转到**<遇险位置>**项，按 **[数字]** 键输入GNSS信息，可旋转 **[CLARITY]** 旋钮选择光标的位置；

d:旋转频道旋钮将光标转到**<发送频率>**项，按 **[确认]** 键打开选择发送DSC频率对话框，有3种发送模式：

1.MULTI->多频率，呼叫将在6个频率上发送。

2.AUTO ->自动频率，呼叫将在6个频率上轮流发送，时间间隔在3.5~4.5分钟之间。

3.单频率，呼叫将在被选择的频率上发送。

e:长按 **[DISTRESS]** 键5秒钟，5秒钟后发送遇险报警呼叫。

设备发送完遇险报警呼叫后进入等待应答呼叫模式。在该模式下设备已经跳转到相应的遇险专用频道上准备通话，并且在20~50秒范围内的随机时间重复发出报警声音，如果3.5~4.5分钟内没有接收到应答呼叫，那么设备自动再次发送遇险报警呼叫。选择**<停止>**项，设备将停止自动重发，选择**<重发>**项，设备将立即重发遇险报警呼叫。

若设备被误发射了遇险报警呼叫，那么要按照如下操作及时的取消该报警：

a) 在等待应答呼叫模式下选择**<取消>**项，发送报警取消呼叫取消该报警。

b) 使用无线电在相关的频率上报告自己的信息。例如：“所有船舶。。。所有船舶。。。所有船舶。。。这里是(本船的名称和本台的呼号)，MMSI是XXXXXXXXXX，我的位置是XX度XX分，XXX度XX分，在XXXX年XX月XX日XX点XX分取消我的未指明类型遇险报警！”

c) 继续其他操作。

◇ 接收遇险报警应答呼叫

当设备接收到遇险报警应答呼叫时，会发出报警声音，显示报警应答呼叫包含的信息，同时设备已经跳转到相关的遇险专用频道等待通话，显示器显示如图4.1.2所示界面。



图4.1.2

◇ 接收遇险报警呼叫

当设备接收到遇险报警呼叫时，会发出报警声音，显示报警呼叫包含的信息，同时设备已经自动转到相应的遇险专用频道等待通话，显示器显示如图4.1.3所示界面。

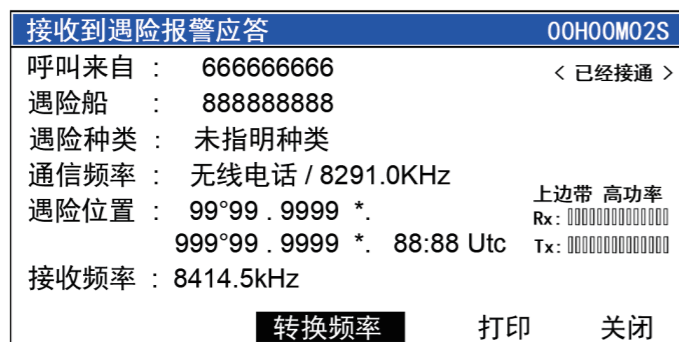

图4.1.3

如果要切换遇险专用频道，那么选择<转换频率>项，按 [确认] 键，打开遇险专用频道列表，选择相应的频道。

若要转发该条报警，那么选择<转发>项，按 [确认] 键，打开转发类型菜单，选择转发到单台或海域，输入目标后按 [确认] 键打开选择发送DSC频率对话框，选择发送模式，然后再按 [确认] 键发送呼叫。

若要发送遇险报警应答呼叫，那么选择<应答>项，按 [确认] 键发送应答呼叫。

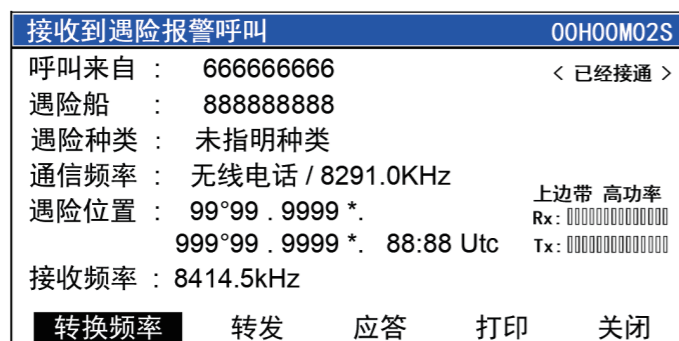
按 [取消] 键或者选择<关闭>项返回到主界面操作。

◆ 遇险报警转发呼叫

◇ 将遇险报警转发到某个海域

a: 按面板上的 [呼叫] 键，打开呼叫类型列表。

b: 使用频道旋钮选择<转发遇险报警到海域>项，按 [确认] 键打开编辑界面，如图4.2.1所示。



图4.2.1

c: 旋转频道旋钮选择<呼叫海域>项，按 [确认] 键打开海域类型选择对话框，选择想要发送的海域类型，然后再使用数字键输入海域信息，可旋转 [CLARITY] 旋钮选择光标的位置。

d: 旋转频道旋钮选择<遇险船>项，使用数字键盘输入遇险船的MMSI号码，也可以按 [确认] 键打开通讯录，从通讯录中选择MMSI号码。

e: 旋转频道旋钮选择<遇险种类>项，遇险的种类包括：火灾、进水、碰撞、搁浅、倾斜、沉没、失控、未指明种类、弃船、海盗、有人落水共11种。默认为：未指明种类，按 [确认] 键确认。

f: 旋转频道旋钮选择<遇险位置>项，使用数字键输入遇险船的位置信息，可旋转 [CLARITY] 旋钮选择光标的位置。

g: 旋转频道旋钮将光标转到<发送频率>项，按 [ENT] 键打开选择发送DSC频率对话框，有3种发送模式：

1. MULTI->多频率，呼叫将在6个频率上发送。
2. AUTO ->自动频率，呼叫将在6个频率上轮流发送，时间间隔在3.5~4.5分钟之间。
3. 单频率，呼叫将在被选择的频率上发送。

选择模式后，按 [确认] 键确认。

h: 旋转频道旋钮选择<发送>项，按 [确认] 键发送遇险报警转发呼叫。

◇ 接收转发到海域的遇险报警呼叫

参见4.1.3节接收遇险报警呼叫的操作，显示器显示如图4.2.2所示界面。



图4.2.2

◇ 将遇险报警转发到某个单台

- a.按面板上的 [呼叫] 键，打开呼叫类型列表。
- b.使用频道旋钮选择<转发遇险报警到单台>项，按 [确认] 键打开编辑界面，如图4.2.3所示。

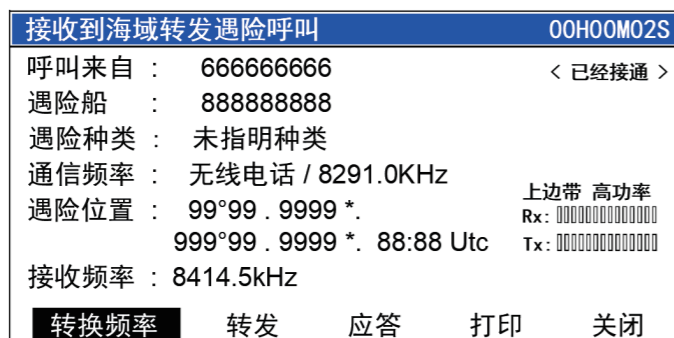

图4.2.3

- c.旋转频道旋钮选择<呼叫目标>项，使用数字键盘输入目标船的MMSI号码，也可以按 [确认] 键打开通讯录，从通讯录中选择MMSI号码。
- d.旋转频道旋钮选择<遇险船>项，使用数字键盘输入遇险船的MMSI号码，也可以按 [确认] 键打开通讯录，从通讯录中选择MMSI号码。
- e.旋转频道旋钮选择<遇险种类>项，遇险的种类包括：火灾、进水、碰撞、搁浅、倾斜、沉没、失控、未指明种类、弃船、海盗、有人落水共11种。默认为：未指明种类，按 [确认] 键确认。
- f.旋转频道旋钮选择<遇险位置>项，使用数字键输入遇险船的位置信息，可旋转 [CLARITY] 旋钮选择光标的位置。
- g.旋转频道旋钮将光标转到<发送频率>项，按 [确认] 键打开选择发送DSC频率对话框，有3种发送模式：
 - 1.MULTI->多频率，呼叫将在6个频率上发送。
 - 2.AUTO ->自动频率，呼叫将在6个频率上轮流发送，时间间隔在3.5~4.5分钟之间。
 - 3.单频率，呼叫将在被选择的频率上发送。

选择模式后，按 [确认] 键确认。

h.旋转频道旋钮选择<发送>项，按 [确认] 键发送遇险报警转发呼叫。

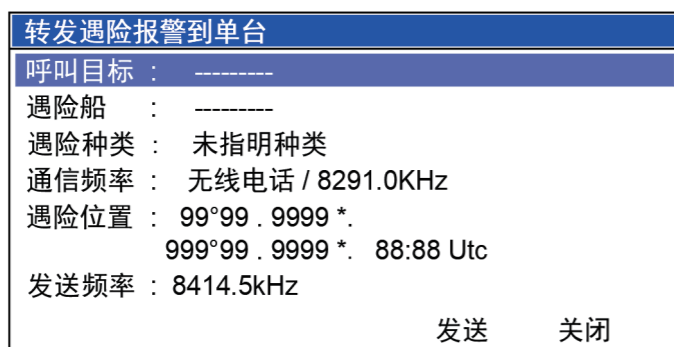
◇ 接收转发到单台的遇险报警应答呼叫

参见4.1.2节接收遇险报警应答呼叫的操作，显示器显示如图4.2.4所示界面。



图4.2.4

◇ 接收转发到单台的遇险报警呼叫

参见4.1.3节接收遇险报警呼叫的操作，显示器显示如图4.2.5所示界面。

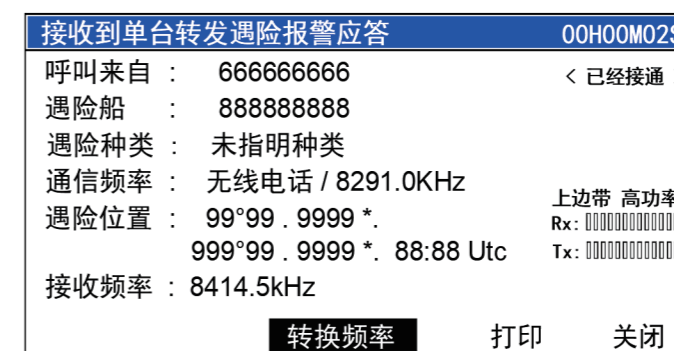

图4.2.5

普通呼叫操作

※DSC的操作须在设备有正确的MMSI号码后才可以进行，如果没有有效的MMSI号码，那么按面板上的[**DISTRESS**]键和[**呼叫**]键时，会弹出没有MMSI号码警告提示框。以下操作默认为设备已经设置了有效的MMSI号码以及正确连接了GNSS设备。

◆ 单台呼叫

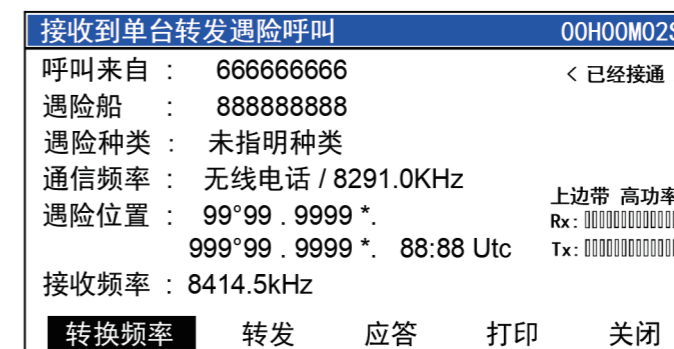
◇ 发送单台呼叫

- a:按面板上的[**呼叫**]键，打开呼叫类型列表。
b:使用频道旋钮选择<单台呼叫>项，按[**确认**]键打开编辑界面，如图5.1.1所示。



图5.1.1

c:旋转频道旋钮选择<呼叫目标>项，使用数字键盘输入目标的MMSI号码，也可以按[**确认**]键打开通讯录，从通讯录中选择MMSI号码。

d:旋转频道旋钮选择<呼叫种类>项，按[**确认**]键打开呼叫种类列表，选择后按[**确认**]键确认。

e:旋转频道旋钮选择<通信频率>项，按[**确认**]键打开通信频率类型列表，选择频率信息或者位置信息，然后按[**确认**]键返回到编辑界面，使用数字键盘输入相应的频率数字或者位置信息，可旋转[**CLARITY**]旋钮选择光标的位置。

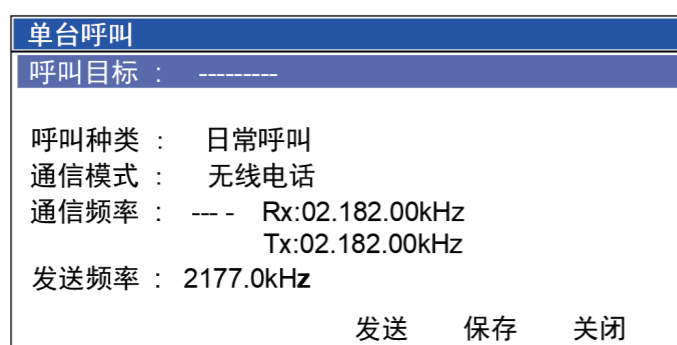
f:旋转频道旋钮选择<发送频率>项，按[**确认**]键打开发送DSC频率列表，按[**确认**]键确认。

g:旋转频道旋钮选择<发送>项，按[**确认**]键发送单台呼叫。

h:发送完单台呼叫后，设备等待应答呼叫，用户可以选择<重发>项，按[**确认**]键再一次发送该条呼叫。

※选择<保存>项，将该条呼叫保存到呼叫文件中。

◇ 接收单台应答呼叫

当设备接收到单台应答呼叫时，会发出提示声音。显示应答呼叫包含的信息，如图5.1.2所示，同时设备已经跳转到相关的通话频率上等待通话。



图5.1.2

选择<打印>项，按[**确认**]键打印该条呼叫。

选择<关闭>项，按[**确认**]键关闭该界面，返回到主界面操作。

◇ 接收单台呼叫

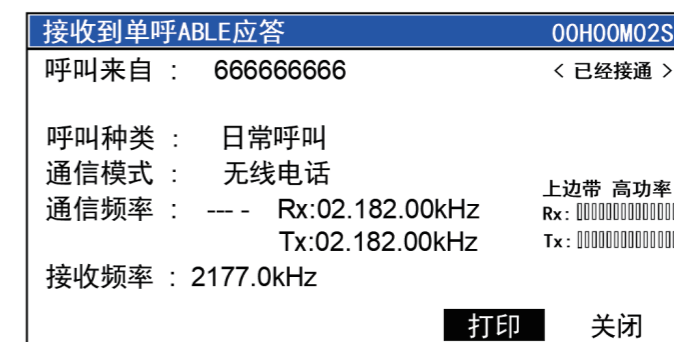
当设备接收到单台呼叫时，会发出提示声音，显示该呼叫包含的信息，如图5.1.3所示。



图5.1.3

如果需要应答，则选择<应答>项，按[**确认**]键发送应答呼叫。

如果需要半应答，则选择<半应答>项，按[**确认**]键打开半应答原因对话框，选择相应的原因后，按[**确认**]键确认，发送半应答呼叫。

选择<打印>项，按[**确认**]键打印该条呼叫。

选择<关闭>项，按[**确认**]键关闭该界面，返回到主界面操作。

◆ 海域呼叫

◇ 发送海域呼叫

a:按面板上的[**呼叫**]键，打开呼叫类型列表。

b:使用频道旋钮选择<海域呼叫>项，按[**确认**]键打开编辑界面，如图5.2.1所示。



图5.2.1

- c: 旋转频道旋钮选择<呼叫海域>项, 按 [确认] 键打开海域类型选择对话框, 选择想要发送的海域类型后按 [确认] 键确认; 再使用数字键输入海域信息, 可旋转 [CLARITY] 旋钮选择光标的位置。
 - d: 旋转频道旋钮选择<呼叫种类>项, 按 [确认] 键打开呼叫种类列表, 选择后按 [确认] 键确认。
 - e: 旋转频道旋钮选择<通信频率>项, 使用数字键盘输入相应的频率数字或者位置信息, 可旋转 [CLARITY] 旋钮选择光标的位置。
 - f: 旋转频道旋钮选择<发送频率>项, 按 [确认] 键打开发送DSC频率列表, 按 [确认] 键确认。
 - g: 旋转频道旋钮选择<发送>项, 按 [确认] 键发送该条呼叫。
 - h: 发送完海域呼叫后, 设备已经转到通信频率上准备通话, 用户也可以选择<重发>项, 按 [确认] 键再一次发送该条呼叫。
- ※ 选择<保存>项, 将该条呼叫保存到呼叫文件中。

◇ 接收海域呼叫

当设备接收到海域呼叫时, 会发出提示声音, 显示该呼叫包含的信息, 如图5.2.2所示。

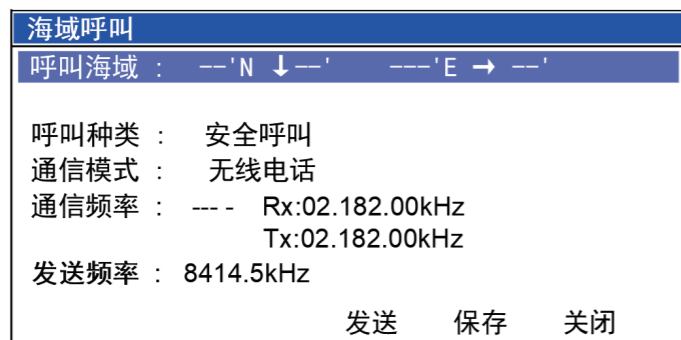

图5.2.2

如果在数字选呼菜单中的频率转换设置为自动, 那么设备在收到呼叫的时候将自动转换频率, 否则在接收到呼叫时, 设备的当前频率并未转换到通信频率上, 需要用户选择<转换频率>项, 按 [确认] 键转换到通信频率。

选择<打印>项, 按 [确认] 键打印该条呼叫。

选择<关闭>项, 按 [确认] 键关闭该界面, 返回到主界面操作。

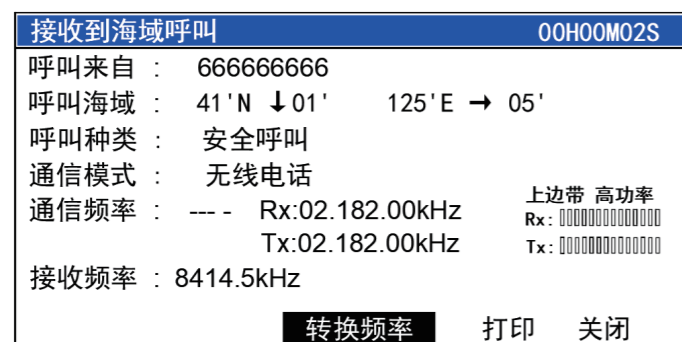
◆ 群组呼叫

◇ 发送群组呼叫

- a: 按面板上的 [呼叫] 键, 打开呼叫类型列表。
- b: 使用频道旋钮选择<群组呼叫>项, 按 [确认] 键打开编辑界面, 如图5.3.1所示。



图5.3.1

- c: 旋转频道旋钮选择<群组号码>项, 使用数字键盘输入群组的ID号码, 也可以按 [确认] 键打开通讯录, 从通讯录中选择群组ID号码。
 - d: 旋转频道旋钮选择<呼叫种类>项, 按 [确认] 键打开呼叫种类列表, 选择后按 [确认] 键确认。
 - e: 旋转频道旋钮选择<通信频率>项, 使用数字键盘输入相应的频率数字或者位置信息, 可旋转 [LARITY] 旋钮选择光标的位置。
 - f: 旋转频道旋钮选择<发送频率>项, 按 [确认] 键打开发送DSC频率列表, 按 [确认] 键确认。
 - g: 旋转频道旋钮选择<发送>项, 按 [确认] 键发送该条呼叫。
 - h: 发送完群组呼叫后, 设备已经转到通信频率上准备通话, 用户也可以选择<重发>项, 按 [确认] 键再一次发送该条呼叫。
- ※ 群组呼叫的种类仅为日常呼叫。
- ※ 选择<保存>项, 将该条呼叫保存到呼叫文件中。

◇ 接收群组呼叫

当设备接收到海域呼叫时，会发出提示声音，显示该呼叫包含的信息，如图5.3.2所示。

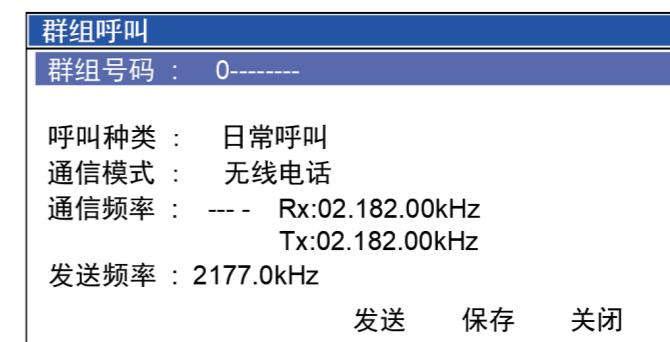

图5.3.2

如果在数字选呼菜单中的频率转换设置为自动，那么设备在收到呼叫的时候将自动转换频率，否则在接收到呼叫时，设备的当前频率并未转换到通信频率上，需要用户选择<转换频率>项，按 [确认] 键转换到通信频率。选择<打印>项，按 [确认] 键打印该条呼叫。选择<关闭>项，按 [确认] 键关闭该界面，返回到主界面操作。

◆ 电话呼叫

◇ 发送电话呼叫

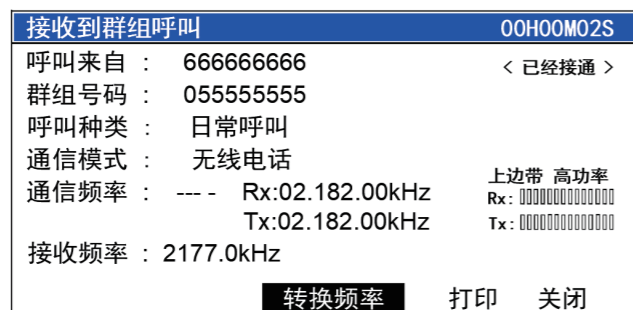
- a:按面板上的 [呼叫] 键，打开呼叫类型列表。
- b:使用频道旋钮选择<电话呼叫>项，按 [确认] 键打开编辑界面，如图5.4.1所示。



图5.4.1

- c:旋转频道旋钮选择<呼叫目标>项，使用数字键盘输入目标的MMSI号码，也可以按 [确认] 键打开通讯录，从通讯录中选择MMSI号码。
 - d:旋转频道旋钮选择<电话号码>项，使用数字键盘输入要接通的电话号码，也可以按 [确认] 键打开通讯录，从通讯录中选择电话号码。
 - e:旋转频道旋钮选择<发送频率>项，按 [确认] 键打开发送DSC频率列表，按 [确认] 键确认。
 - f:旋转频道旋钮选择<发送>项，按 [确认] 键发送该条呼叫。
 - g:发送完电话呼叫后，设备等待应答呼叫，用户可以选择<重发>项，按 [确认] 键再一次发送该条呼叫。
- ※选择<保存>项，将该条呼叫保存到呼叫文件中。

◇ 接收电话应答呼叫

当设备接收到电话应答呼叫时，会发出提示声音。显示应答呼叫包含的信息，如图5.4.2所示，同时设备已经跳转到相关的通话频率上等待通话。

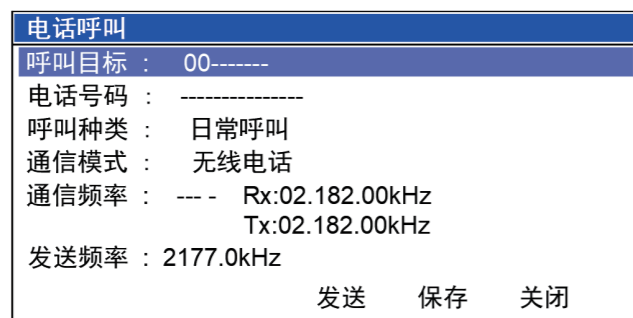

图5.4.2

- 选择<打印>项，按 [确认] 键打印该条呼叫。
- 选择<关闭>项，按 [确认] 键关闭该界面，返回到主界面操作。

◇ 接收电话呼叫

当设备接收到电话呼叫时，会发出提示声音，显示该呼叫包含的信息，如图5.4.3所示。



图5.4.3

如果需要应答，则选择<应答>项，按 [确认] 键发送应答呼叫。

如果需要半应答，则选择<半应答>项，按 [确认] 键打开半应答原因对话框，选择相应的原因后，按 [确认] 键确认，发送半应答呼叫。

选择<打印>项，按 [确认] 键打印该条呼叫。

选择<关闭>项，按 [确认] 键关闭该界面，返回到主界面操作。

◆ 位置请求呼叫

◇ 发送位置请求呼叫

a:按面板上的 [呼叫] 键，打开呼叫类型列表。

b:使用频道旋钮选择<位置请求呼叫>项，按 [确认] 键打开编辑界面，如图5.5.1所示界面。



图5.5.1

c:旋转频道旋钮选择<呼叫目标>项，使用数字键盘输入目标船的MMSI号码，也可以按 [确认] 键打开通讯录，从通讯录中选择MMSI号码。

d:旋转频道旋钮选择<发送频率>项，按 [确认] 键打开发送DSC频率列表，按 [确认] 键确认。

e:旋转频道旋钮选择<发送>项，按 [确认] 键发送该条呼叫。

f:发送完位置请求呼叫后，设备等待应答呼叫，用户可以选择<重发>项，按 [确认] 键再一次发送该条呼叫。

※选择<保存>项，将该条呼叫保存到呼叫文件中。

◇ 接收位置请求应答呼叫

当设备接收到位置请求应答呼叫时，会发出提示声音，显示应答呼叫包含的信息，如图5.5.2所示界面。



图5.5.2

选择<打印>项，按 [确认] 键打印该条呼叫。

选择<关闭>项，按 [确认] 键关闭该界面，返回到主界面操作。

◇ 接收位置请求呼叫

当设备接收到位置请求呼叫时，会发出提示声音，显示该呼叫包含的信息，如图5.5.3 所示界面。



图5.5.3

选择<应答>项，按 [确认] 键发送应答呼叫。
选择<打印>项，按 [确认] 键打印该条呼叫。
选择<关闭>项，按 [确认] 键关闭该界面，返回到主界面操作。

◆ 测试呼叫

◇ 发送测试呼叫

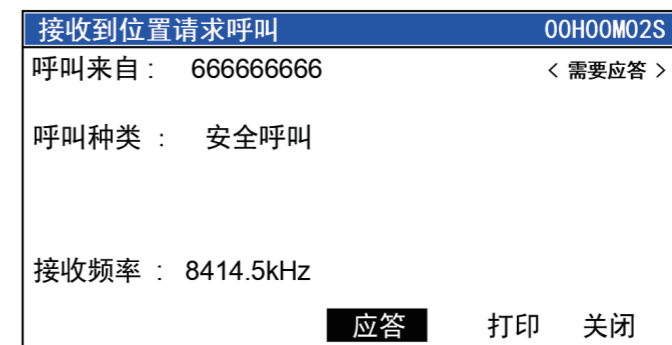
- a:按面板上的 [呼叫] 键，打开呼叫类型列表。
- b:使用频道旋钮选择<测试呼叫>项，按 [确认] 键打开编辑界面，如图5.6.1所示界面。
- c:旋转频道旋钮选择<呼叫目标>项，使用数字键盘输入目标船的MMSI号码，也可以按 [确认] 键打开通讯录，从通讯录中选择MMSI号码。



图5.6.1

- d:旋转频道旋钮选择<发送频率>项，按 [确认] 键打开发送DSC频率列表，按 [确认] 键确认。
 - e:旋转频道旋钮选择<发送>项，按 [确认] 键发送该条呼叫。
 - f:发送完测试呼叫后，设备等待应答呼叫，用户可以选择<重发>项，按 [确认] 键再一次发送该条呼叫。
- ※选择<保存>项，将该条呼叫保存到呼叫文件中。

◇ 接收测试应答呼叫

当设备接收到测试应答呼叫时，会发出提示声音，显示应答呼叫包含的信息，如图5.6.2所示界面。



图5.6.2

选择<打印>项，按 [确认] 键打印该条呼叫。
选择<关闭>项，按 [确认] 键关闭该界面，返回到主界面操作。

◇ 接收测试呼叫

当设备接收到测试呼叫时，会发出提示声音，显示该呼叫包含的信息，如图5.6.3所示界面。



图5.6.3

选择<应答>项，按 [确认] 键发送应答呼叫。
选择<打印>项，按 [确认] 键打印该条呼叫。
选择<关闭>项，按 [确认] 键关闭该界面，返回到主界面操作。

◆ 中立船呼叫

※ 只有在设备的特殊呼叫被使能情况下才可以发送中立船呼叫。

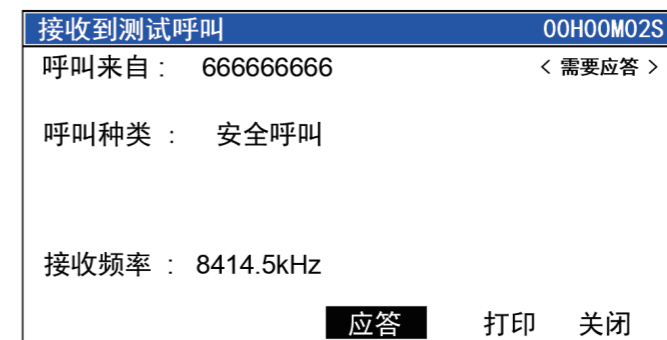
使能特殊呼叫操作详见菜单操作。

按面板上的 [呼叫] 键打开呼叫类型列表，选择<中立船呼叫>项。

参见本手册第5.2节有关海域呼叫的操作中立船呼叫的显示界面如图5.7.1和图5.7.2所示界面。

中立船呼叫的呼叫种类仅为安全呼叫。



图5.7.1



图5.7.2

◆ 医疗船呼叫

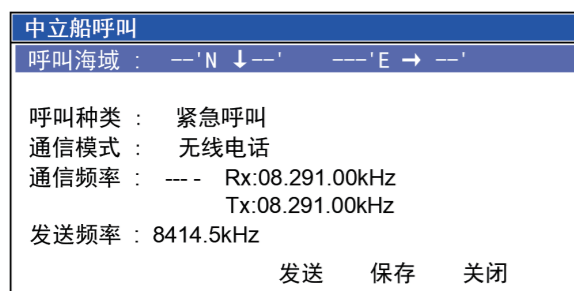
※ 只有在设备的特殊呼叫被使能情况下才可以发送医疗船呼叫。

使能特殊呼叫操作详见菜单操作。

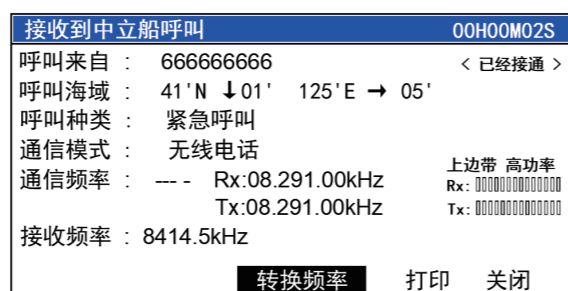
按面板上的 [呼叫] 键打开呼叫类型列表，选择<医疗船呼叫>项。

参见本手册第5.2节有关海域呼叫的操作，医疗船呼叫的显示界面如图5.8.1和图5.8.2所示界面。

医疗船呼叫的呼叫种类仅为安全呼叫。



图5.8.1



图5.8.2

◆ 查询呼叫

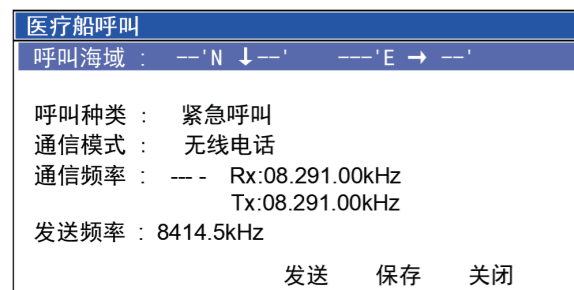
当设备接收到查询呼叫时，会发出提示声音，显示该呼叫包含的信息，如图5.9.1所示界面。

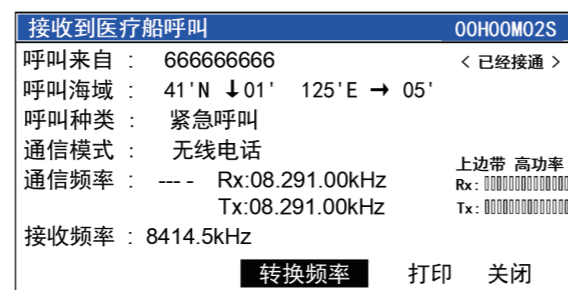

图5.9.1

选择<应答>项，按 [确认] 键发送应答呼叫。

选择<打印>项，按 [确认] 键打印该条呼叫。

选择<关闭>项，按 [确认] 键关闭该界面，返回到主界面操作。

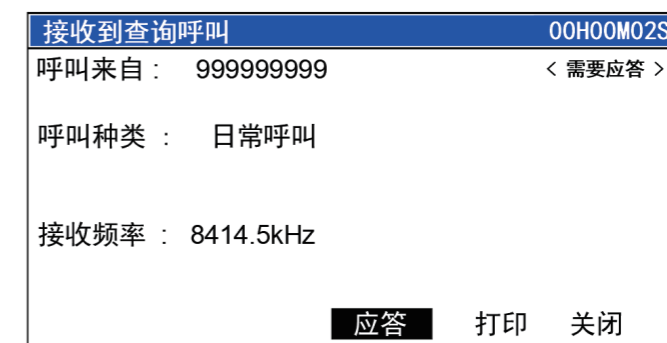
菜单操作

◆ 如何使用菜单

按面板上的 [菜单] 键打开主菜单，如图6.1所示。旋转频道旋钮选择要进入的子菜单，再按 [确认] 键确认并进入子菜单。按 [取消] 键返回上一级菜单。



图6.1

◆ 通讯录

设备允许操作者存储30条船舶、30条岸台，30条群组的MMSI号码和30条电话号码，方便在发送CALL时输入目标MMSI号码。

如何增加/编辑一个条目：

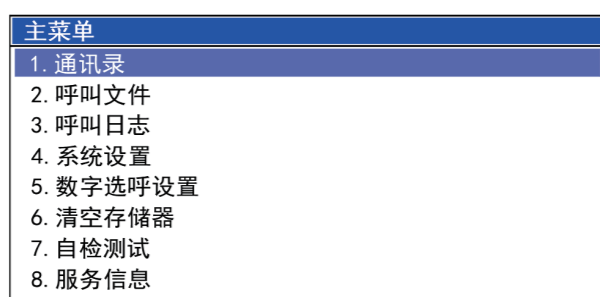
a:在主菜单中选择<通讯录>项，按 [确认] 键打开通讯录列表，选择要编辑的条目类型，按 [确认] 键打开通讯录界面。

b:旋转频道旋钮选择要编辑的条目，按 [确认] 键打开条目操作对话框，如图6.2.1。

c:旋转频道旋钮选择<编辑选中的条目>项，按 [确认] 键打开“编辑条目信息”对话框，如图6.2.2，使用数字键盘输入条目的名称和号码，可以使用 [CLARITY] 和 [CH/ENT] 旋钮移动字符下面的光标。

d:信息输入完毕后，旋转频道旋钮到<保存>项，按 [确认] 键确认保存。

如何删除条目：

在本节b步骤打开的条目操作对话框中，旋转频道旋钮选择<删除选中的条目>项或者<删除所有条目>项，按 [确认] 键后设备将删除对应的条目。



图6.2.1



图6.2.2

◆ 呼叫文件

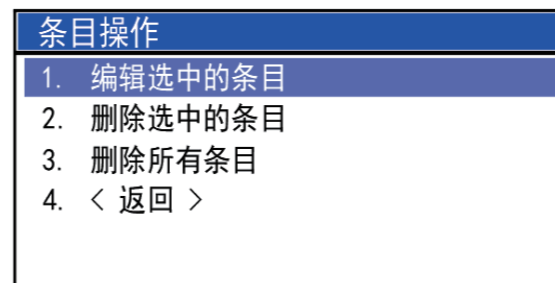
设备可以保存50条预先编辑的普通呼叫，编辑呼叫方法参见《5.普通呼叫操作》。

a:在主菜单中选择<呼叫文件>项，按 [确认] 键打开呼叫文件。

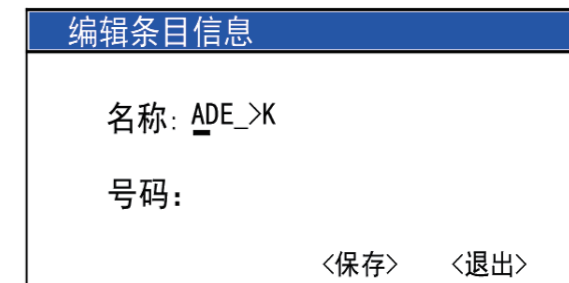
b:旋转频道旋钮选择要操作的呼叫，按 [确认] 键打开呼叫文件操作对话框，如图6.3。



图6.3

c:旋转频道旋钮选择要进行的操作。

d:按 [取消] 键关闭呼叫文件。

※在查看呼叫文件界面下，可以选择<发送>项发送该条呼叫。

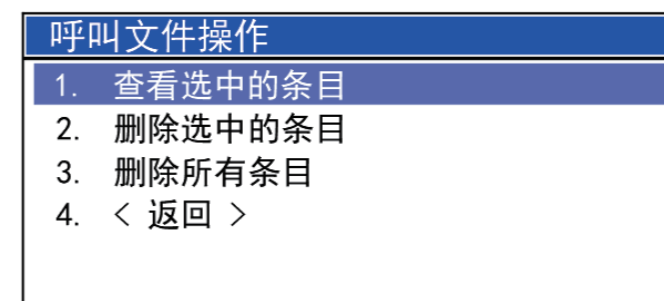
◆ 呼叫日志

设备可以保存发射和接收的报警呼叫与普通呼叫，分别可以保存100条。

- a: 在主菜单中选择<呼叫日志>项，按 [确认] 键打开呼叫日志列表。
- b: 旋转频道旋钮选择要查看的呼叫类型，按 [确认] 键打开相应的呼叫日志文件。
- c: 旋转频道旋钮选择要操作的呼叫，按 [确认] 键打开呼叫日志操作对话框，如图6.4。



图6.4

- d: 旋转频道旋钮选择要进行的操作。
- e: 按 [取消] 键关闭呼叫日志文件。

◆ 系统设置

◇ 本地时间设置

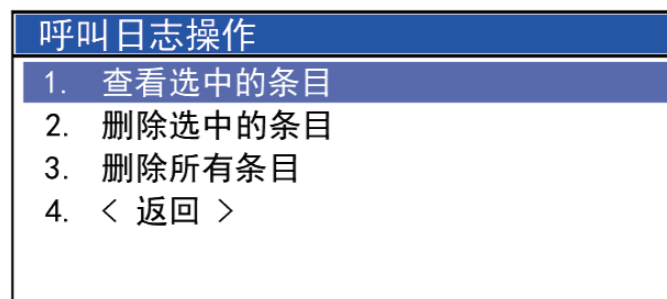
设备内部有RTC时间模块，当设备没有GNSS连接时，内部的RTC开始工作，产生本地日期和时间。

如何设置内部RTC：

- a: 在系统设置菜单中选择<本地时间>项，按 [确认] 键打开本地时间设置对话框，如图6.5.1所示。
- b: 使用数字键输入日期与时间信息，也可旋转频道旋钮控制光标的位置，更改该位置上的数字。输入完毕后按选择<保存>项，按 [确认] 保存时间信息。



图6.5.1

◇ 时差设置

当设备接收到有效的GNSS 数据时，设备可以通过UTC 时间计算出本地时间并显示在主界面上。

计算公式为：RTC = UTC + 时差。

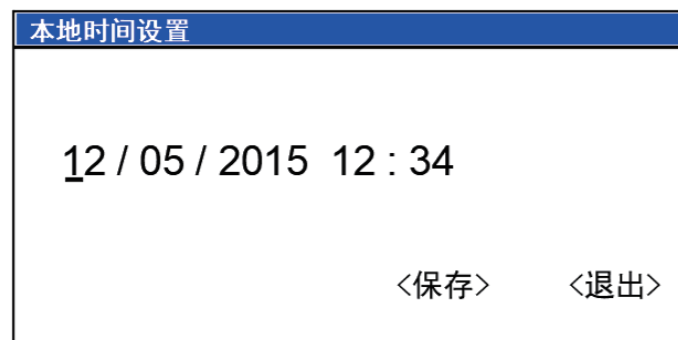
如何设置时差：

- a: 在系统设置菜单中选择<时差>项，按 [确认] 键打开时差设置对话框，如图6.5.2.1。
- b: 按 [确认] 键打开时差列表，如图6.5.2.2。
- c: 旋转频道旋钮选择要设置的时差，按 [确认] 键确认。
- d: 按 [取消] 键返回到系统设置菜单。



图6.5.2.1



图6.5.2.2

◇ 超时设置

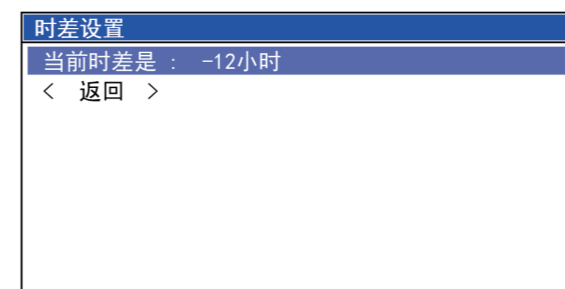
在操作者按PTT的时间超出设定的时间时，设备将自动关闭发射机终止发射。设备出厂默认值为5分钟。

如何设置超时时间：

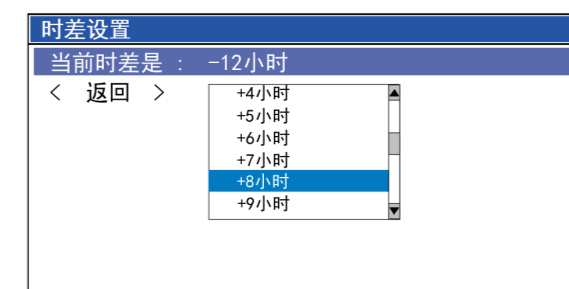
- a: 在系统设置菜单中选择<超时设置>项，按 [确认] 键打开超时时间设置对话框，如图6.5.3.1。
- b: 按 [确认] 键打开超时时间列表，如图6.5.3.2。
- c: 旋转频道旋钮选择要设置的超时时间，按 [确认] 键确认。
- d: 按 [取消] 键返回到系统设置菜单。



图6.5.3.1



图6.5.3.2

◇ 扬声器设置

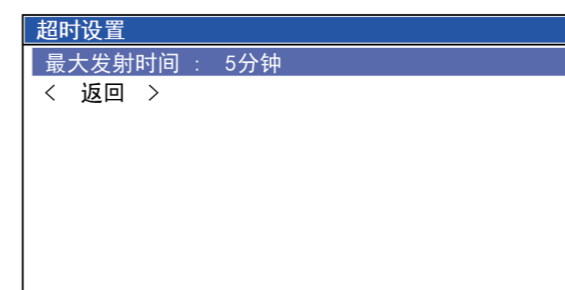
设备在前面板上内置了扬声器，另外也支持外接扬声器，根据用户需要进行选择。

- a:在系统设置菜单中选择<扬声器设置>项，按 [确认] 键打开扬声器设置对话框，如图6.5.4.1。
- b:按 [确认] 键打开扬声器类型列表，如图6.5.4.2。
- c:旋转频道旋钮选择要设置的扬声器类型，按 [确认] 键确认。
- d:按 [取消] 键返回到系统设置菜单。

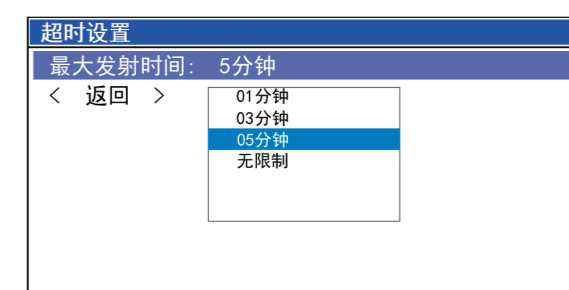

图6.5.4.1



图6.5.4.2

◇ 语言设置

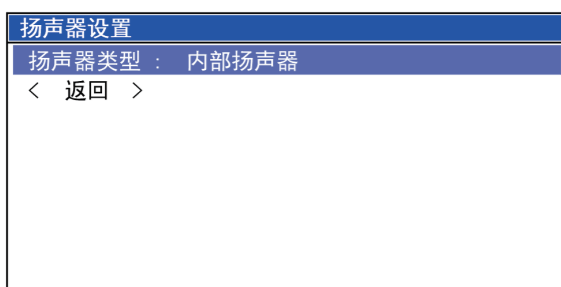
设备支持中文和英文显示。

- a:在系统设置菜单中选择<语言设置>项，按 [确认] 键打开选择语言对话框，如图6.5.5.1。
- b:按 [确认] 键打开语言类型列表，如图6.5.5.2。
- c:旋转频道旋钮选择要设置的语言，按 [确认] 键确认，返回到主界面。

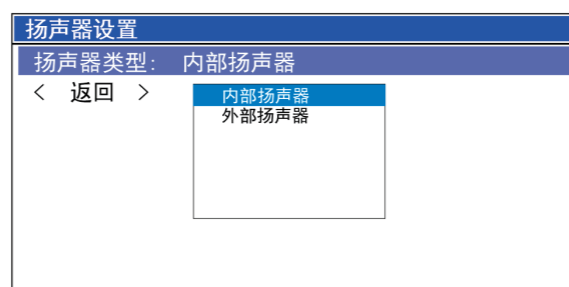

图6.5.5.1



图6.5.5.2

◇ 声音设置

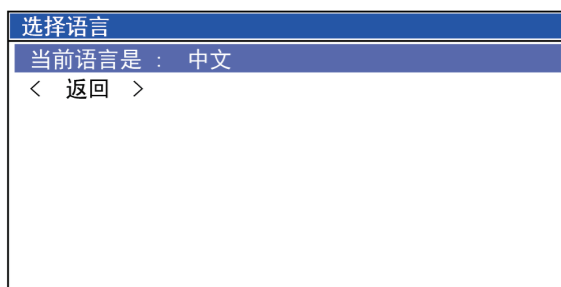
设备允许用户关闭按键声音和错误操作提示音。

- a:在系统设置菜单中选择<声音设置>项，按 [确认] 键打开声音设置对话框，如图6.5.6.1。
- b:旋转频道旋钮选择要设置的声音类型，按 [确认] 键打开状态列表，如图6.5.6.2。
- c:旋转频道旋钮选择状态，按 [确认] 键确认。
- d:按 [取消] 键返回到系统设置菜单。

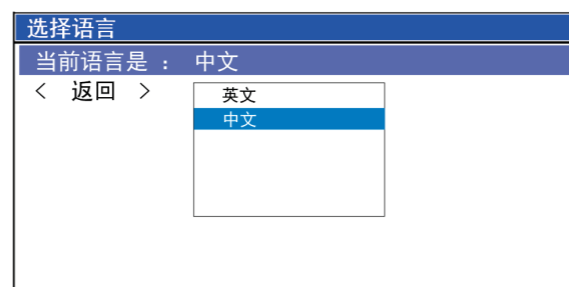

图6.5.6.1



图6.5.6.2

◇ 天调设置

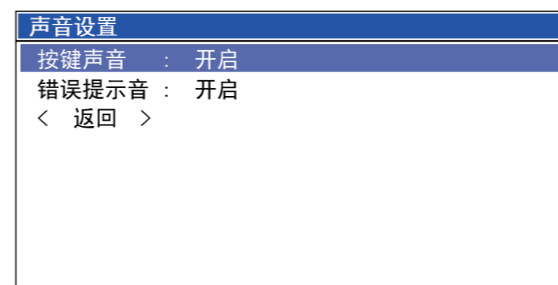
- a:在系统设置菜单中选择<天调设置>项，按 [确认] 键打开天调设置对话框，如图6.5.7.1。
- b:按 [确认] 键打开天调类型列表，如图6.5.7.2。
- c:旋转频道旋钮选择类型，按 [确认] 键确认。
- d:按 [取消] 键返回到系统设置菜单。

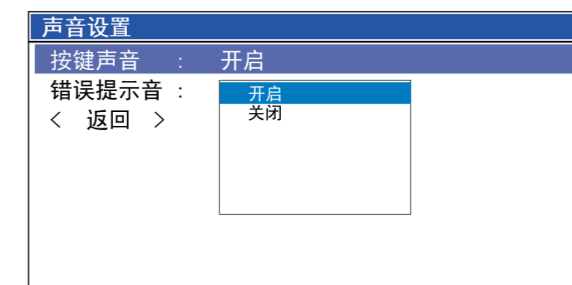

图6.5.7.1



图6.5.7.2

- ※设备实际连接的天调必须要与该菜单中设置的天调类型一致。
- ※如果连接的是AT-500，天调类型设置为“通用天调”，如果连接的是AT-131/141，天调类型设置为“专用天调”。
- ※通用天调是指不需要调谐信号线（START,KEY）的天调。

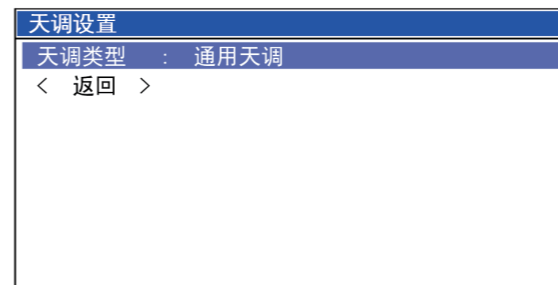
◇ 功率设置 (仅韩国地区版本可用)

- a:在系统设置菜单中选择<功率设置>项,按 [确认] 键打开功率设置对话框,如图6.5.8.1。
- b:输入更改密码“199707”,按 [确认] 键,如图6.5.8.2。
- c:按 [确认] 键打开功率范围列表,选择要设置的功率范围,按 [确认] 键确认。
- d:按 [取消] 键返回到系统设置菜单。

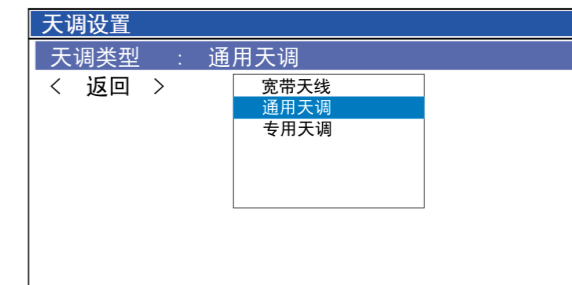

图6.5.8.1



图6.5.8.2

◇ 通信速率设置

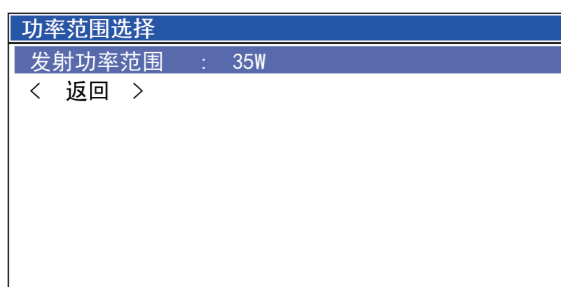
- a:在系统设置菜单中选择<通信速率设置>项,按 [确认] 键打开通信速率设置对话框,如图6.5.9.1。
- b:旋转频道旋钮选择速率选择要设置的项,按 [确认] 键打开速率列表,如图6.5.9.2。
- c:旋转频道旋钮选择速率,按 [确认] 键确认。
- d:按 [取消] 键返回到系统设置菜单。

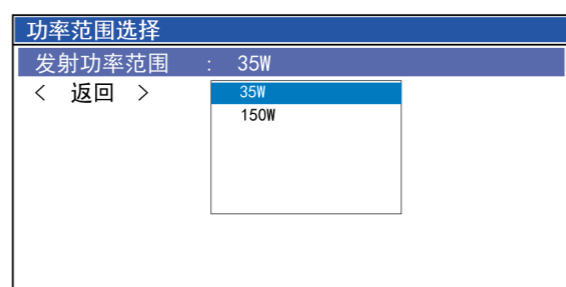

图6.5.9.1



图6.5.9.2

※连接GNSS时一定要选择对应的速率,一般GPS的输入速率是4800bps,北斗的输入速率是9600bps。

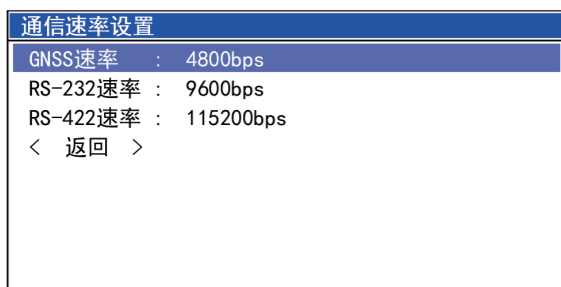
◇ 显示模式设置

- a:在系统设置菜单中选择<显示模式设置>项,按 [确认] 键打开显示模式设置对话框,如图6.5.10.1。
- b:旋转频道旋钮选择要设置的项,按 [确认] 键打开模式列表,如图6.5.10.2。
- c:旋转频道旋钮选择模式,按 [确认] 键确认。
- d:按 [取消] 键返回到系统设置菜单。

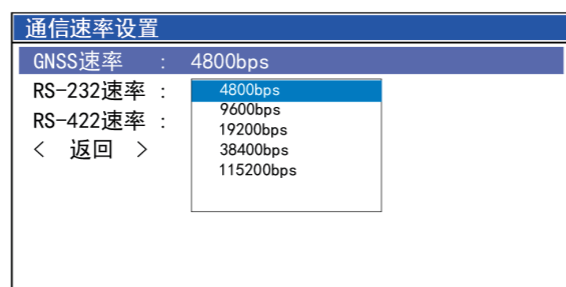

图6.5.10.1



图6.5.10.2

◆ 数字选呼设置

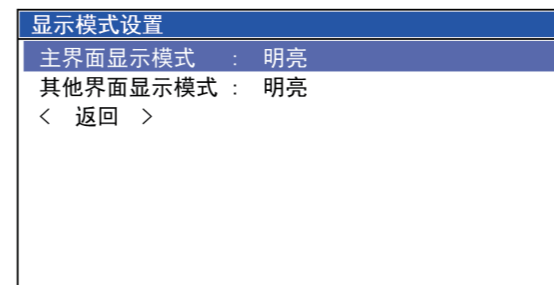
◇ 本机MMSI设置

- 设备可以允许用户更改3次本机MMSI号码,超过3次后要输入更改密码才可以继续更改MMSI号码。
- a:在数字选呼设置菜单中选择<本机MMSI设置>项,按 [确认] 键打开位置设置对话框,如图6.6.1。
 - b:使用数字键输入MMSI号码,旋转频道旋钮控制光标的位置,更改该位置上的数字。输入完毕后按选择<保存>项保存MMSI信息。
 - c:按 [取消] 键返回到数字选呼设置菜单。

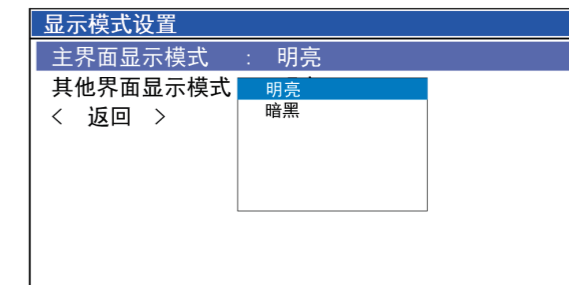

图6.6.1

◇ 位置设置

当设备没有外接GNSS时，设备允许用户手动输入GNSS信息。

- a:在数字选呼设置菜单中选择<位置设置>项，按 [确认] 键打开位置设置对话框，如图6.6.2。
- b:使用数字键输入GNSS信息，旋转频道旋钮控制光标的位置，更改该位置上的数字。输入完毕后按选择<保存>项保存GNSS信息。
- c:按 [取消] 键返回到数字选呼设置菜单。

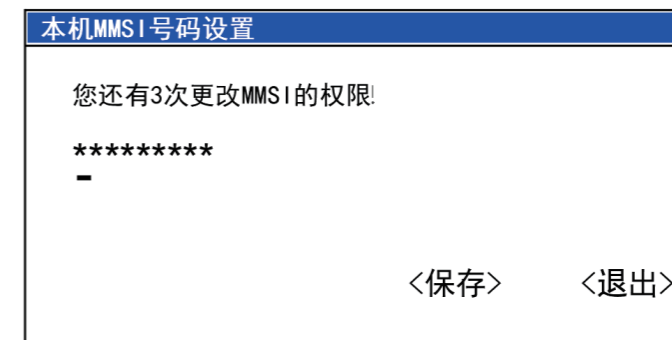

图6.6.2

◇ 应答设置

设备允许用户自行设置呼叫的应答模式，所有呼叫的应答模式默认为手动应答。

- a:在数字选呼设置菜单中选择<应答设置>项，按 [确认] 键打开应答设置对话框，如图6.6.3.1。
- b:旋转频道旋钮选择要设置的呼叫类型，按 [确认] 键打开应答模式列表，如图6.6.3.2。
- c:旋转频道旋钮选择应答模式，按 [确认] 键确认。
- d:按 [取消] 键返回到数字选呼设置菜单。

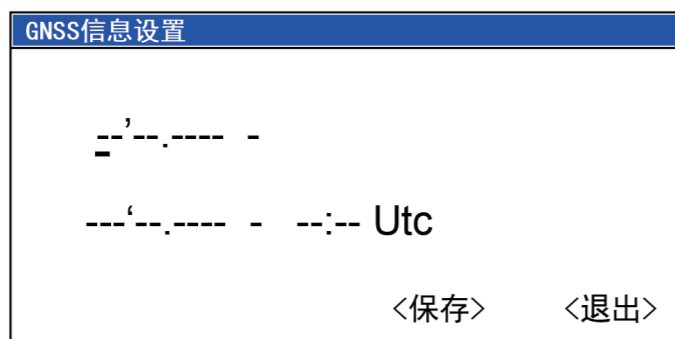

图6.6.3.1



图6.6.3.2

◇ 打印设置

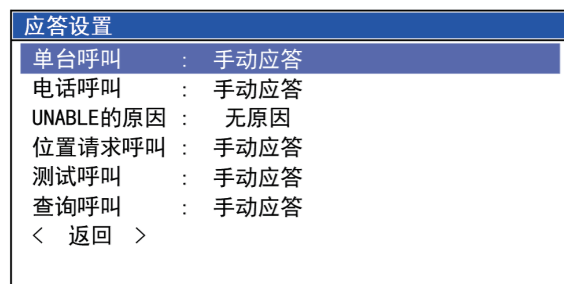
设备支持连接串口打印机(需连接指定型号，具体请咨询供应商)。可以设置打印模式为自动打印或者手动打印两种模式，设备默认是手动打印模式。

- a:在系统设置菜单中选择<打印设置>项，按 [确认] 键打开打印设置对话框，如图6.6.4.1。
- b:旋转频道旋钮选择需要打印的呼叫类型，按 [确认] 键打开状态列表，如图6.6.4.2。
- c:旋转频道旋钮选择要设置的打印模式，按 [确认] 键确认。
- d:按 [取消] 键返回到数字选呼设置菜单。

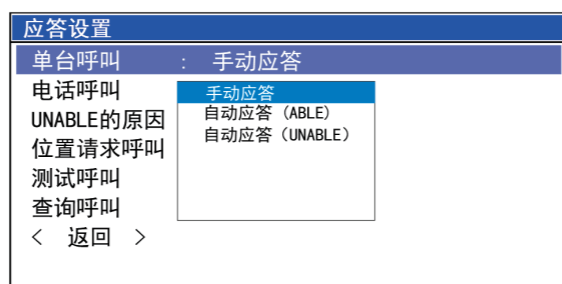

图6.6.4.1



图6.6.4.2

◇ 频率转换设置

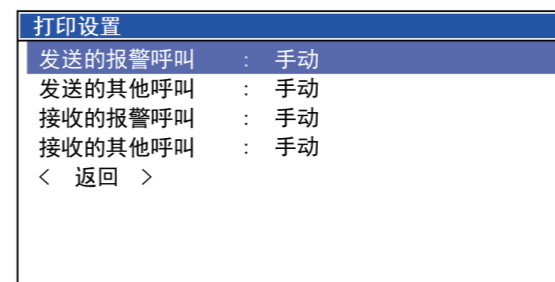
当设备收到普通呼叫时，设备允许用户设置通话频率的转换模式，分为自动转换和手动转换。

- 日常呼叫和安全呼叫默认的是手动转换，紧急呼叫默认的是自动转换。
- a:在数字选呼设置菜单中选择<频率转换设置>项，按 [确认] 键打开频率转换设置对话框，如图6.6.5.1。
- b:旋转频道旋钮选择要设置的呼叫类型，按 [确认] 键打开转换模式列表，如图6.6.5.2。
- c:旋转频道旋钮选择转换模式，按 [确认] 键确认。
- d:按 [取消] 键返回到数字选呼设置菜单。

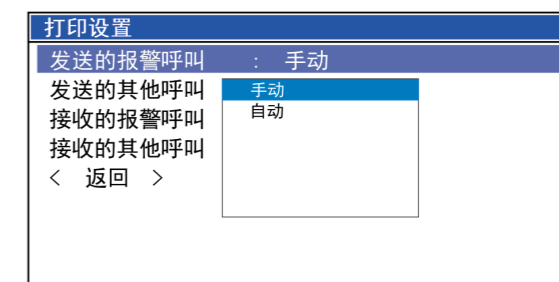

图6.6.5.1



图6.6.5.2

◆ 特殊呼叫设置

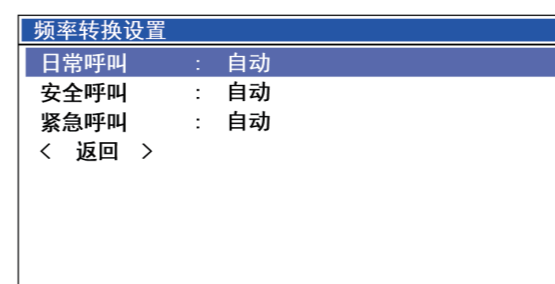
特殊呼叫包括中立船呼叫和医疗船呼叫，设备默认特殊呼叫是禁止发送的，用户可在该菜单项中使能特殊呼叫。

- a:在数字选呼设置菜单中选择<特殊呼叫设置>项，按 [确认] 键打开特殊呼叫设置对话框，如图6.6.6.1。
- b:旋转频道旋钮选择要设置的呼叫类型，按 [确认] 键打开特殊呼叫状态列表，如图6.6.6.2。
- c:旋转频道旋钮选择特殊呼叫的使能状态，按 [确认] 键确认。
- d:按 [取消] 键返回到数字选呼设置菜单。

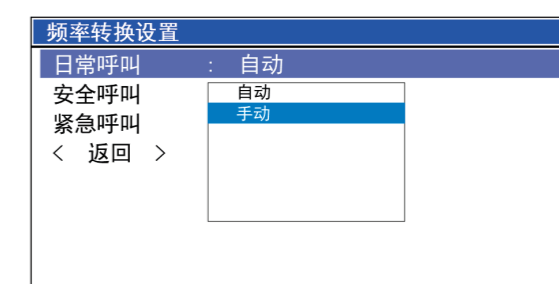

图6.6.6.1

◆ 清空存储器

清空存储器将清除用户所设置的所以信息，包括用户频道的频率，通讯录信息和菜单项的设置信息。

- a:在主菜单中选择<清空存储器>项，按 [确认] 键打开恢复出厂设置对话框。
- b:旋转频道旋钮选择<确认>项，按 [确认] 键将清除存储器上所有的用户信息。
- c:按 [取消] 键返回主菜单。

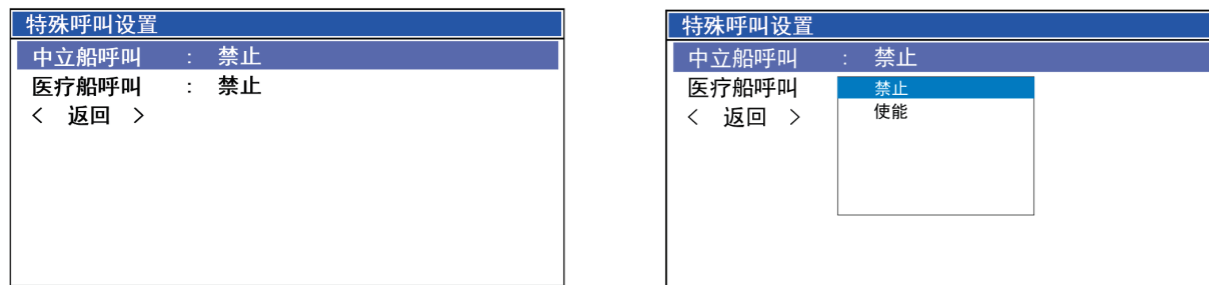
◆ 自检测试

- a:在主菜单中选择<自检测试>项，按 [确认] 键开启自动检测功能。
- b:待检测完后按 [取消] 键或者 [确认] 键返回主菜单。

◆ 服务信息

显示设备的机器编号和版本信息。

- a:在主菜单中选择<服务信息>项，按 [确认] 键打开服务信息对话框。
- b:按 [取消] 键返回主菜单。

GNSS连接

FT-7900的GNSS接口可连接带有RS232或者RS422输出的GNSS接收机，接收的GNSS数据格式为NMEA0183 v-ersion 2.0中的RMC,GGA,GLL,ZDA,GNS语句。

当设备正确连接到了GNSS并且接收到有效的GNSS信息时，显示器显示"自动输入"，如果设备与GNSS连接中断30秒后，那么设备将保存最后接收的GNSS信息，显示器显示"—信号丢失 - 30s --"。

设备的GNSS信息如果在4小时内没有得到更新，那么设备将会发出警告提示声音，弹出GNSS链接警告消息框，如图7.1所示，按 [取消] 键关闭消息框。

设备的GNSS信息如果在23.5小时内没有得到更新，那么设备将会发出警告提示声音，弹出GNSS链接警告消息框，如图7.2所示，按 [取消] 键关闭警告信息。



图7.1



图7.2

系统接口规格说明

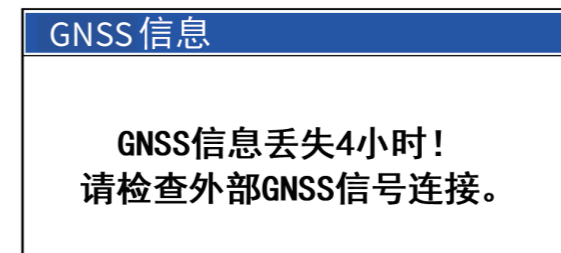
■主机单元前视图说明

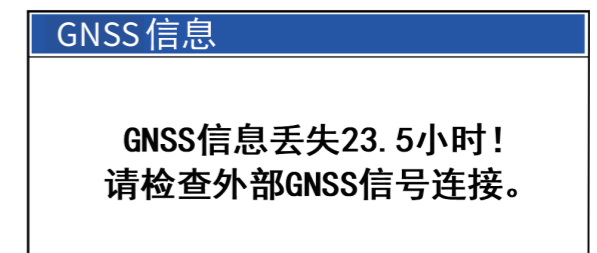
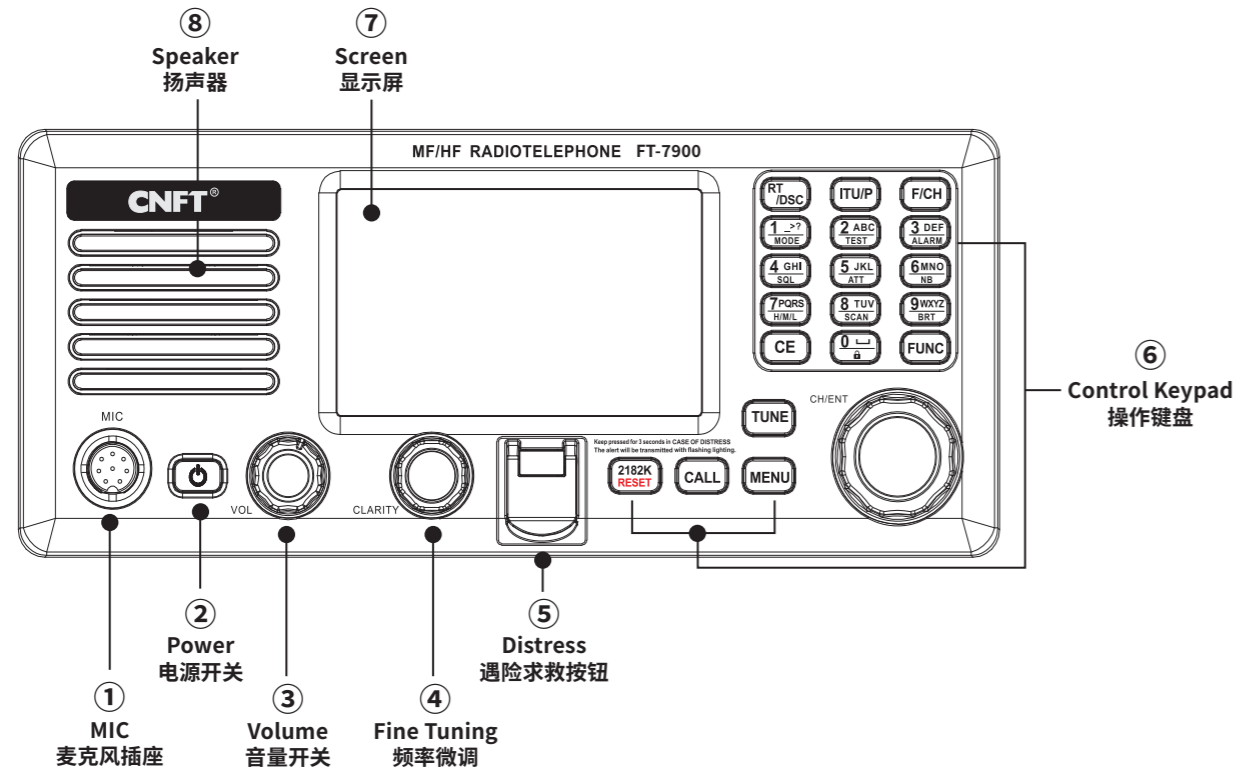

■主机单元后视图说明

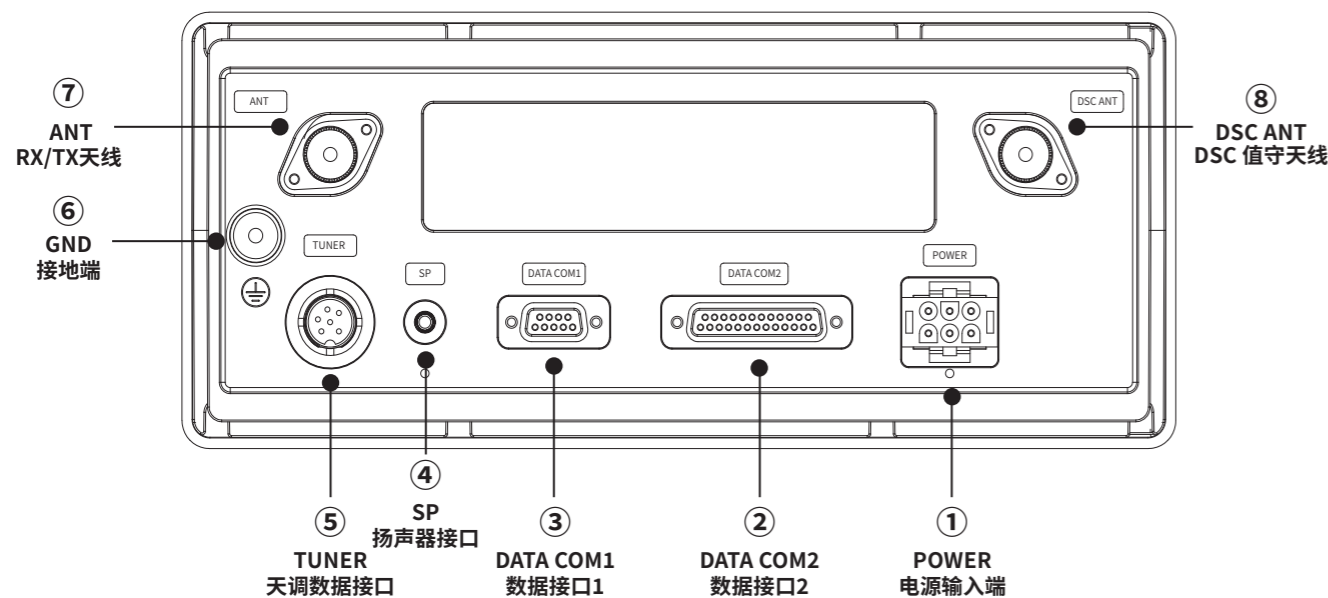

主机单元后视图接口规格

① POWER(电源输入接口)

※注明: 主机单元电源输入接口 (12V (10.8V-15.6V) DC: 30A)

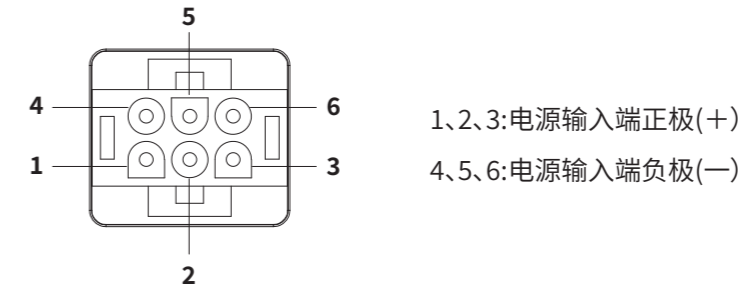

1、2、3:电源输入端正极(+)
4、5、6:电源输入端负极(-)

② DATA COM2(数据接口2)

※注明: 各类信息数据的输入和输出接口

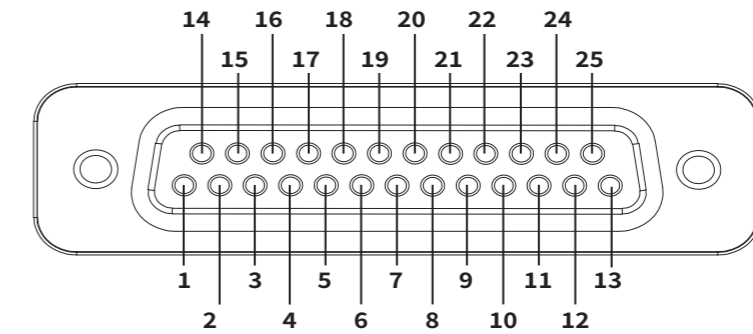

序号	定义	功能
1	NC	空
2	NC	空
3	GNSS+	定位数据输入+
4	GNSS-	定位数据输入-
5	EXT_ALARM+	报警输入控制+
6	EXT_ALARM-	报警输入控制-

序号	定义	功能
7	RS422_RXD+	422串口RXD+
8	RS422_RXD-	422串口RXD-
9	RS422_TXD-	422串口TXD-
10	RS422_TXD+	422串口TXD+
11	NC	空
12	NC	空
13	NC	空
14	NC	空
15	NC	空
16	NC	空
17	NC	空
18	NC	空
19	NC	空
20	NC	空
21	NC	空
22	12V	DC:12V输出
23	12V	DC:12V输出
24	GND	地
25	GND	地

③ DATA COM1(数据接口1)

※注明: 各类信息数据的输出与输入接口

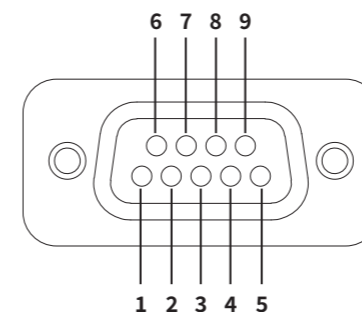

序号	定义	功能
1	NC	空
2	RS232_TXD	232串口TXD
3	RS232_RXD	232串口RXD
4	NC	空
5	GND	地
6	B00T1	启动1
7	B00T0	启动2
8	USB_DM	USB数据口 DM端
9	USB_DP	USB数据口 DP端

④ SP(3.5mm外接扬声器输出接口)

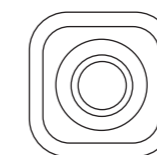

⑤ TUNER(天调数据连接接口)

※注明: 主机单元与天调数据连接接口 (可选配FT-600AT、ICOM. AT-120/130/140)

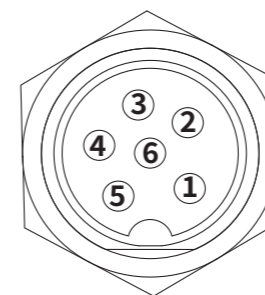

序号	定义	功能
1	12V(输出)	DC 12V
2	GND	地
3	START	启动调谐
4	NC	空
5	NC	空
6	OK	调谐完成

⑥ GND(整机接地端口)

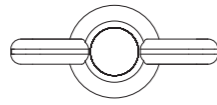

⑦ ANT(RX/TX天线接口)

⑧ DSC ANT(DSC值守天线接口)

■ FT-7900设备与FT-600AT(天调)接线图说明

FT-7900设备天调数据接口规格

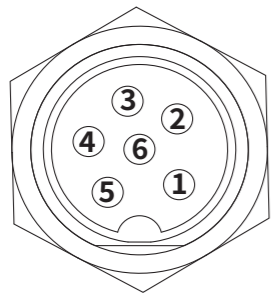

TUNER(同⑤号接口)

序号	定义	功能
1	12V(输出)	DC 12V
2	GND	地
3	START	启动调谐
4	NC	空
5	NC	空
6	OK	调谐完成

FT-600AT(天调)接线规格

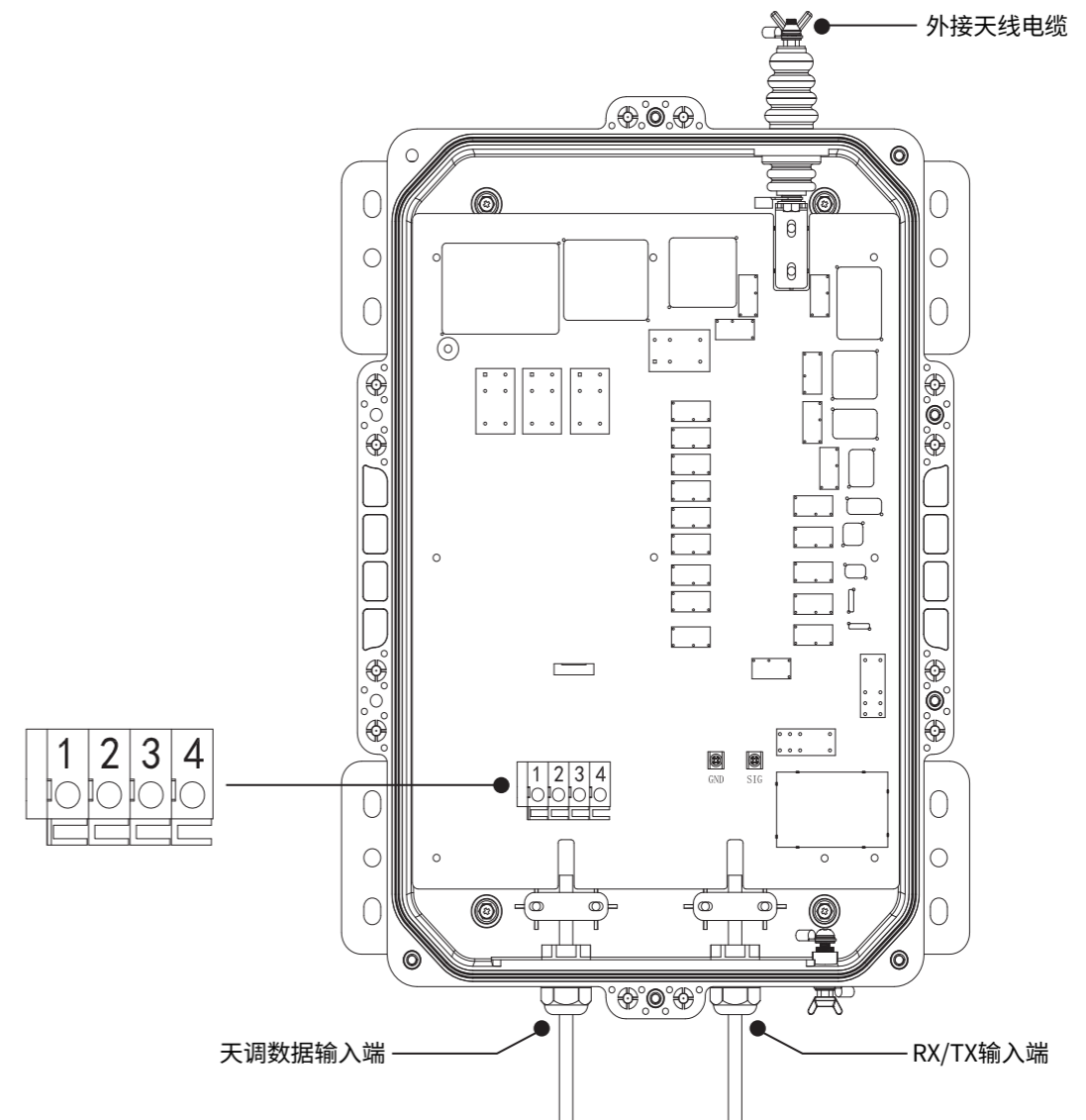

序号	定义	功能	序号	定义	功能
1	OK	调谐完成	3	GND	地
2	START	启动调谐	4	12V(输入)	DC 12V

FT-500AT(天调)接线规格

■ FT-7900设备可选配其他型号(天调调谐器)匹配使用

(1)可选配(日本ICOM原产天调型号AT-120、AT-130、AT-140)

(2)安装接线方式：请对照FT-7900设备后端(天调数据TUNER接口⑤)数据输出规格接线说明。

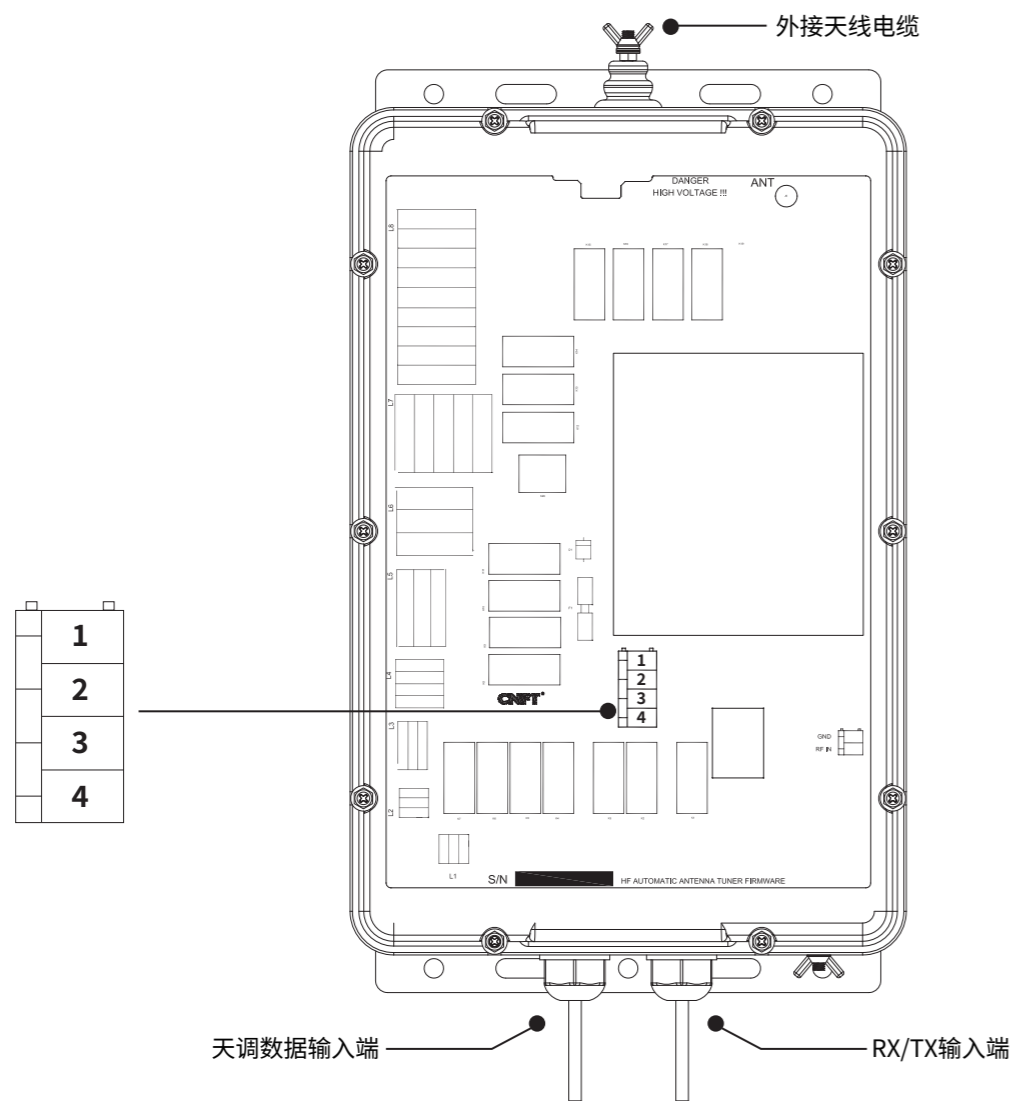

序号	定义	功能	序号	定义	功能
2	GND	地	3	12V(输入)	DC 12V

附录

◆ 中频-2MHz单边带载波频率

CH NO	Ship Receive(kHz)	Ship Transmit(kHz)
241	1635	2060
242	1638	2063
243	1641	2066
244	1644	2069
245	1647	2072
246	1650	2075
247	1653	2078
248	1656	2081
249	1659	2084
250	1662	2087
251	1665	2090
252	1668	2093
253	1671	2096
254	1674	2099
255	1677	2102
256	1680	2105
257	1683	2108
258	1686	2111
259	1689	2114
260	1692	2117
261	1695	2120
262	1698	2123
263	1701	2126
264	1704	2129
265	1707	2132
266	1710	2135
267	1713	2138
268	1716	2060
269	1719	2063
270	1722	2066

CH NO	Ship Receive(kHz)	Ship Transmit(kHz)
271	1725	2069
272	1728	2072
273	1731	2075
274	1734	2078
275	1737	2081
276	1740	2084
277	1743	2087
278	1746	2090
279	1749	2093
280	1752	2096
281	1755	2099
282	1758	2102
283	1761	2105
284	1764	2108
285	1767	2111
286	1770	2114
287	1773	2117
288	1776	2120
289	1779	2123
290	1782	2126
291	1785	2129
292	1788	2132
293	1791	2135
294	1794	2138
295	1797	2060

◆ 高频-4/6MHz单边带载波频率

4 MHz SSB (J3E)		
ITU CH NO	Ship RX	Ship TX
401	4357	4065
402	4360	4068
403	4363	4071
404	4366	4074
405	4369	4077
406	4372	4080
407	4375	4083
408	4378	4086
409	4381	4089
410	4384	4092
411	4387	4095
412	4390	4098
413	4393	4101
414	4396	4104
415	4399	4107
416	4402	4110
417	4405	4113
418	4408	4116
419	4411	4119
420	4414	4122
421	4417	4125
422	4420	4128
423	4423	4131
424	4426	4134
425	4429	4137
426	4432	4140
427	4435	4143
428	4351	4351
429	4354	4354
430	4146	4146
431	4149	4149
432(01)	4000	4000
433(02)	4003	4003
434(03)	4006	4006
435(04)	4009	4009
436(05)	4012	4012

4 MHz SSB (J3E)		
ITU CH NO	Ship RX	Ship TX
437(06)	4015	4015
438(07)	4018	4018
439(08)	4021	4021
440(09)	4024	4024
441(10)	4027	4027
442(11)	4030	4030
443(12)	4033	4033
444(13)	4036	4036
445(14)	4039	4039
446(15)	4042	4042
447(16)	4045	4045
448(17)	4048	4048
449(18)	4051	4051
450(19)	4054	4054
451(20)	4057	4057
452(21)	4060	4060

6 MHz SSB (J3E)		
ITU CH NO	Ship RX	Ship TX
601	6501	6200
602	6504	6203
603	6507	6206
604	6510	6209
605	6513	6212
606	6516	6215
607	6519	6218
608	6522	6221
609	6224	6224
610	6227	6227
611	6230	6230

◆ 高频-8MHz单边带载波频率

8 MHz SSB (J3E)-Duplex		
ITU CH NO	Ship RX	Ship TX
801	8719	8195
802	8722	8198
803	8725	8201
804	8728	8204
805	8731	8207
806	8734	8210
807	8737	8213
808	8740	8216
809	8743	8219
810	8746	8222
811	8749	8225
812	8752	8228
813	8755	8231
814	8758	8234
815	8761	8237
816	8764	8240
817	8767	8243
818	8770	8246
819	8773	8249
820	8776	8252
821	8779	8255
822	8782	8258
823	8785	8261
824	8788	8264
825	8791	8267
826	8794	8270
827	8797	8273
828	8800	8276
829	8803	8279
830	8806	8282
831	8809	8285
832	8812	8288
833	8291	8291
834	8707	8707
835	8710	8710
836	8713	8713

◆ 高频-12MHz单边带载波频率

8 MHz SSB (J3E)-Simplex		
ITU CH NO	Ship RX	Ship TX
837	8716	8716
838	8294	8294
839	8297	8297
840(01)	8101	8101
841(02)	8104	8104
842(03)	8107	8107
843(04)	8110	8110
844(05)	8113	8113
845(06)	8116	8116
846(07)	8119	8119
847(08)	8122	8122
848(09)	8125	8125
849(10)	8128	8128
850(11)	8131	8131
851(12)	8134	8134
852(13)	8137	8137
853(14)	8140	8140
854(15)	8143	8143
855(16)	8146	8146
856(17)	8149	8149
857(18)	8152	8152
858(19)	8155	8155
859(20)	8158	8158
860(21)	8161	8161
861(22)	8164	8164
862(23)	8167	8167
863(24)	8170	8170
864(25)	8173	8173
865(26)	8176	8176
866(27)	8179	8179
867(28)	8182	8182
868(29)	8185	8185
869(30)	8188	8188
870(31)	8191	8191

CH Nos in () are ITU Nos (RR Section C-1)

12 MHz SSB (J3E)		
CH NO.	Ship RX	Ship TX
1201	13077	12230
1202	13080	12233
1203	13083	12236
1204	13086	12239
1205	13089	12242
1206	13092	12245
1207	13095	12248
1208	13098	12251
1209	13101	12254
1210	13104	12257
1211	13107	12260
1212	13110	12263
1213	13113	12266
1214	13116	12269
1215	13119	12272
1216	13122	12275
1217	13125	12278
1218	13128	12281
1219	13131	12284
1220	13134	12287
1221	13137	12290
1222	13140	12293
1223	13143	12296
1224	13146	12299
1225	13149	12302
1226	13152	12305
1227	13155	12308
1228	13158	12311
1229	13161	12314
1230	13164	12317
1231	13167	12320
1232	13170	12323
1333	13173	12326
1234	13176	12329
1235	13179	12332

12 MHz SSB (J3E)		
CH NO.	Ship RX	Ship TX
1236	13182	12335
1237	13185	12338
1238	13188	12341
1239	13191	12344
1240	13194	12347
1241	13197	12350
1242	12353	12353
1243	12356	12356
1244	12359	12359
1245	12362	12362
1246	12365	12365

◆ 高频-16MHz单边带载波频率

16 MHz SSB (J3E)		
CH NO.	Ship RX	Ship TX
1601	17242	16360
1602	17245	16363
1603	17248	16366
1604	17251	16369
1605	17254	16372
1606	17257	16375
1607	17260	16378
1608	17263	16381
1609	17266	16384
1610	17269	16387
1611	17272	19390
1612	17275	16393
1613	17278	16396
1614	17281	16399
1615	17284	16402
1616	17287	16405
1617	17290	16408
1618	17293	16411
1619	17296	16414
1620	17299	16417
1621	17302	16420
1622	17305	16423
1623	17308	16426
1624	17311	16429
1625	17314	16432
1626	17317	16435
1627	17320	16438
1628	17323	16441
1629	17326	16444
1630	17329	16447
1631	17332	16450
1632	17335	16453
1633	17338	16456
1634	17341	16459
1635	17344	16462

◆ 高频-18/19MHz单边带载波频率

16 MHz SSB (J3E)		
CH NO.	Ship RX	Ship TX
1636	17347	16465
1637	17350	16468
1638	17353	16471
1639	17356	16474
1640	17359	16477
1641	17362	16480
1642	17365	16483
1643	17368	16486
1644	17371	16489
1645	17374	16492
1646	17377	16495
1647	17380	16498
1648	17383	16501
1649	17386	16504
1650	17389	16507
1651	17392	16510
1652	17395	16513
1653	17398	16516
1654	17401	16519
1655	17404	16522
1656	17407	16525
1657	16528	16528
1658	16531	16531
1659	16534	16534
1660	16537	16537
1661	16540	16540
1662	16543	16543
1663	16546	16546

18/19 MHz SSB (J3E)		
CH NO.	Ship RX	Ship TX
1801	19755	18780
1802	19758	18783
1803	19761	18786
1804	19764	18789
1805	19767	18792
1806	19770	18795
1807	19773	18798
1808	19776	18801
1809	19779	18804
1810	19782	18807
1811	19785	18810
1812	19788	18813
1813	19791	18816
1814	19794	18819
1815	19797	18822
1816	18825	18825
1817	18828	18828
1818	18831	18831
1819	18834	18834
1820	18837	18837
1821	18840	18840
1822	18843	18843

◆ 高频-22MHz单边带载波频率

22 MHz SSB (J3E)		
CH NO.	Ship RX	Ship TX
2201	22696	22000
2202	22699	22003
2203	22702	22006
2204	22705	22009
2205	22708	22012
2206	22711	22015
2207	22714	22018
2208	22717	22021
2209	22720	22024
2210	22723	22027
2211	22726	22030
2212	22729	22033
2213	22732	22036
2214	22735	22039
2215	22738	22042
2216	22741	22045
2217	22744	22048
2218	22747	22051
2219	22750	22054
2220	22753	22057
2221	22756	22060
2222	22759	22063
2223	22762	22066
2224	22765	22069
2225	22768	22072
2226	22771	22075
2227	22774	22078
2228	22777	22081
2229	22780	22084
2230	22783	22087

22 MHz SSB (J3E)		
CH NO.	Ship RX	Ship TX
2231	22786	22090
2232	22789	22093
2233	22792	22096
2234	22795	22099
2235	22798	22102
2236	22801	22105
2237	22804	22108
2238	22807	22111
2239	22810	22114
2240	22813	22117
2241	22816	22120
2242	22819	22123
2243	22822	22126
2244	22825	22129
2245	22828	22132
2246	22831	22135
2247	22834	22138
2248	22837	22141
2249	22840	22144
2250	22843	22147
2251	22846	22150
2252	22849	22153
2253	22852	22156
2254	22159	22159
2255	22162	22162
2256	22165	22165
2257	22168	22168
2258	22171	22171
2259	22174	22174
2260	22177	22177

◆ 高频-25/26MHz单边带载波频率

25/26 MHz SSB (J3E)		
CH NO.	Ship RX	Ship TX
2501	26145	25070
2502	26148	25073
2503	26151	25076
2504	26154	25079
2505	26157	25082
2506	26160	25085
2507	26163	25088
2508	26166	25091
2509	26169	25094
2510	26172	25097
2511	25100	25100
2512	25103	25103
2513	25106	25106
2514	25109	25109
2515	25112	25112
2516	25115	25115
2517	25118	25118

设备维护

◇ 故障排除

现象	可能原因	排除方法
无法开机	电源接反;电源线未插紧; 设备输入电压超压	检查电源连接方向,重新正确连接; 插紧电源线; 确认设备输入电压在设备工作电压范围内
发射功率不足	天线安装不到位,如松动、角度偏差; 周围有遮挡物影响信号	重新安装天线,确保稳固且角度合适; 移除天线周围的遮挡物
接收信号弱或无信号	天线未正确连接; 天线被异物缠绕	检查天线连接部位,重新连接; 清理天线周围的异物
通信杂音大	设备未接地; 附近有干扰源,如其他电器设备	为设备正确接地; 将设备远离干扰源

◇ 定期检查

请定期对仪器进行以下必要项目的检查,这将有助于仪器保持良好的性能。

项目	现象	操作方法
电源电缆	暴露、破损	更换
电源插头	松动	插紧
显示部件	腐蚀	清洁
供电电压	过压、欠压	检查供电系统

◇ 整机的清洁

仪器表面的灰尘和污渍可以用软布擦除,如果必要,也可以用湿润的软布进行清洁。擦拭液晶表面时,请特别注意,因为它容易被擦伤。不要使用化学清洁剂,因为它们可能会把仪器表面的漆或标记擦掉。